

AUDIO BEAT OSCILLATORS

RADIO

REG. U.S. PAT. OFF.

WORLD

T. R. F.
AND
SUPER
TUNERS

3-TUBE
TRANS-
CEIVER

X

The How-to-Make It Monthly—14th Year

667 tubes
JANUARY

1936

*alignment
& super
page 45*

*coils
P 17*



25c
Per
Copy

DIRECTIONS FOR LINING UP SUPERS

www.americanradiohistory.com



In through the years.

On through the years, for the past twenty-six years, CORNELL-DUBILIER laboratories have been striving for one objective—that of building *better* and *better* condensers.

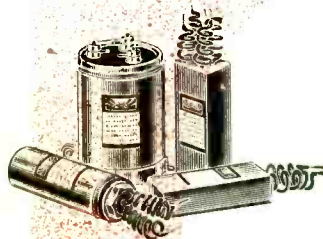

MICA CONDENSERS—Using select India mica as a dielectric and tested by the most exacting methods, have been used as standard equipment by government departments for more than a score of years.

PAPER CONDENSERS—Hermetically sealed in non-corrosive containers, are constructed of the finest linen condenser tissue available. Supplied in a complete capacity range from the smallest .00005 mfd. tubular to the 1,000,000 volt oil filled coupling condenser.

ELECTROLYTICS — Triply sealed against the deteriorating effects of climatic conditions—have won wide popularity among home experimentors and set builders because of their dependability and moderate cost.

HERMETICALLY SEALED TRANSMITTING CONDENSERS—By utilizing Dykanol, the recently developed non-inflammable impregnator, as a dielectric—C-D engineers have further been able to reduce the size and weight of these capacitors, due to the extremely high dielectric strength of this oil medium. Suitable for power amplifiers and brute force filters.

Cornell-Dubilier Capacitors are being used by the leading manufacturers of receivers, transmitters and S.W. apparatus. Try C-D condensers on your next job!

Assure yourself of the satisfaction demanded by these manufacturers. Available at all C-D distributors.

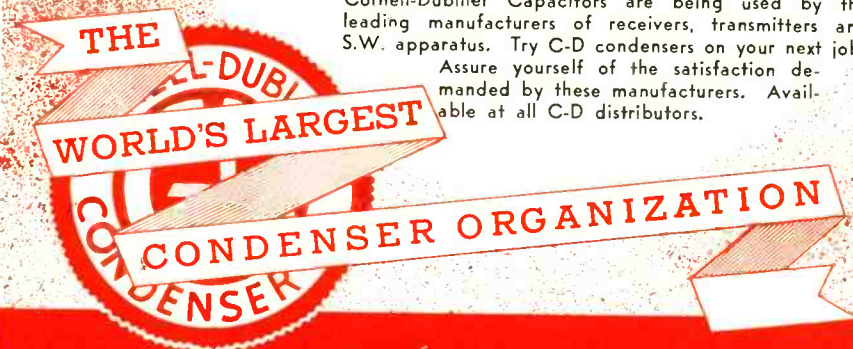

CORNELL-DUBILIER

CORPORATION

4379 BRONX BOULEVARD • NEW YORK

I WILL TRAIN YOU AT HOME IN SPARE TIME FOR A GOOD RADIO JOB!



J. E. SMITH, Pres.,
National Radio Institute

HERE'S PROOF

Manager, Radio Service Dept.

"Before taking the N.R.I. Course, I was a 'dunkie' in a furniture store. Now I have a job as manager of Radio Service Department of one of Mississippi's best furniture stores."
AVID J. SCHUMAKER,
2, Box 105-F, Vicksburg, Miss.

Earns Money Quick in Radio

Joined N.R.I. in a few weeks worked 20 hours a day made \$1.00 a day.



Since that time I have gotten married, bought home, and have one of the nicest jobs a man has ever known."
— **E. LAMAR HINSTON**, 250 Fifth Avenue, Rome, Georgia.

Get my FREE LESSON on Radio Servicing Tips

"It proves that my training is practical, money-making information, that it is easy to understand—that it is just what you need to master Radio. My sample lesson text, "Radio Receiving Troubles—The Cause and Remedy" covers a long list of Radio receiver troubles: A. C., D. C. battery, universal auto, T. R. F., super-heterodyne, all-wave, and other types of sets. And a cross reference system gives you the probable cause and a quick way to locate and remedy these set troubles. A special section is devoted to receiver checking, alignment, balancing, neutralizing and tuning. Get this lesson—Free. No obligation. Mail coupon.

FREE BOOK TELLS HOW MAIL COUPON

Act today for better pay. Act today to break away from a low pay, no-future job—to get away from having to skimp, scrape to pay your bills. Mail coupon for my free 64-page book. It tells you how I will train you at home in your spare time to be a Radio Expert; about my training that has helped hundreds of men to make more money.

Many Radio Experts Make \$30, \$50, \$75 a Week

Consider these facts—think of the good jobs they stand for. Over 20,000,000 Radio sets in use, over 600 broadcasting stations, over 40 manufacturers of Radio sets, over 2,000 manufacturers of parts, over 100 Police Departments Radio equipped, airplanes and airports Radio equipped. Thousands of ships touching every seaport of the world, are Radio equipped. Over 35,000 stores selling sets and parts, over 2,000,000 autos Radio equipped. Loud speaker systems wherever people gather, indoors and outdoors. Commercial Radio stations dotting our coast lines. Radio a big industry—is growing bigger. A few hundred \$30, \$50, \$75 a week jobs have grown to thousands in recent years.

Get Ready Now for Jobs Like These

A spare time or full time service shop; installing, maintaining, operating—broadcast, aviation, commercial, ship, television and police stations. A Radio retail or service business of your own. Installing, maintaining, servicing, loud speaker systems. A service or sales job with a store or jobber. I'll train you for good jobs in many branches of Radio.

Many Make \$5, \$10, \$15 a Week Extra in Spare Time Almost at Once

Every neighborhood can use a good part time serviceman. The day you enroll I start sending you Extra Money Job Sheets which quickly show you how to do Radio repair jobs common in almost every neighborhood. Get my book—see for yourself that many of my students make \$200 to \$1,000 in their spare time while learning.

Your Money Back if Not Satisfied

I'll make this agreement with you. If you are not entirely satisfied with my Lesson and Instruction Service when you finish, I'll refund your tuition.

Find Out What Radio Offers

Mail the coupon. My book of information on Radio's spare time and full time opportunities is free to ambitious men. Read what Radio offers you. Read about the training I give you. Read letters from graduates—what they are doing and earning. There's no obligation. Mail coupon in an envelope or paste it on a penny post card NOW.

J. E. SMITH, President
National Radio Institute, Dept. 6AM4
Washington, D. C.

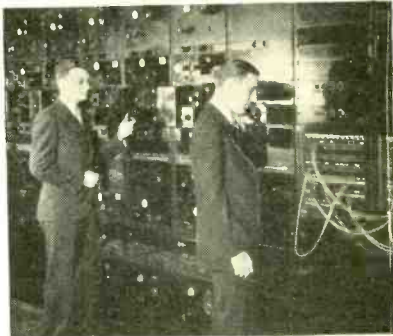

Save Money—Learn At Home My Special Equipment Gives You Broad, Practical Experience

Hold your job. No need to leave home and spend a lot of money to become a Radio Expert. I'll train you quickly and inexpensively right at home in your spare time. You don't need a high school or college education. Many of my successful graduates didn't finish grade school. My practical 50-60 method of training—half with lessons, half with Radio equipment I furnish—gives you broad practical experience—makes learning at home easy, fascinating, practical and quick. There is opportunity for you in Radio. Old jobs are becoming more complicated—many need better trained men. New developments are making new opportunities. Short waves, loud speaker systems, police Radio, auto Radio, aviation Radio, Television—Radio's newest uses are covered by my Training. Here's a field that's growing. It is where you find growth that you find opportunity.

I have helped
hundreds of
men make
more money



MAIL THIS NOW!

J. E. Smith, President
National Radio Institute, Dept. 6AM4
Washington, D. C.

Dear Mr. Smith: Without obligation, send me the Sample Lesson and your free book about spare time and full time Radio opportunities, and how I can train for them at home in spare time. (Please write plainly.)

Name..... Age.....
Address.....
City..... State..... 14X1

The Tested Way to BETTER PAY

RADIO WORLD

The How-to-Make-It Monthly—Fourteenth Year

ROLAND BURKE HENNESSY
Editor

HERMAN BERNARD
Managing Editor

HERBERT E. HAYDEN
Advertising Manager

Table of Contents for JANUARY, 1936

Wind from Quartz Crystals.... 5 <i>Fascinating Utilization of Piezo Electric Effect</i> By S. C. Hight	Frequency Metering and Monitoring 30 <i>All Wave Coverage by Switching</i> By Albert E. Voorhis
Every Channel Heard on D. C. Set 7 <i>Broadcast Super for Car or Boat</i> By John Braden	A Simplified All Wave Receiver. 34 <i>A. C. Model Made for High Gain</i> By Edwin K. Butler
A Three Tube Battery Transceiver 11 <i>Unity Coupled Circuit for 5 or 10 Meters</i> By Max Steir	Audio Frequency Generators... 38 <i>Beat Note Oscillators Diagnosed</i> By Herman Bernard
Simplest Tube Voltmeter 14 <i>Slideback Method, Using Batteries</i> By Jack Tully	Alignment of Superheterodyne 45 <i>All Levels Considered, With and Without A.V.C.</i> By Herman Bernard
The Bank Wound Coil..... 17 <i>Higher Broadcast Q Than Solenoid</i> By Edward M. Shiepe	Three New Metal Tubes..... 48 <i>Curves on One Used for Theory Exposition</i> By Woodring Lawrence
Recording and Playing Back... 18 <i>Inexpensive Quality System</i> By M. N. Beitman	Propagation of Ultra Short Radio Waves 50 <i>Behavior Plotted on Northern Atlantic Coast</i> By Charles R. Burrows
Tuners with Metal Tubes..... 20 <i>T.R.F. and Converter, Plus Glass Tube Super</i> By J. E. Anderson	Simple Exposition of Meter.... 55 <i>Current Is Basis of Everything</i> By Louis Krans
Value of Capacity Tests..... 28 <i>Radio Frequency Problems Simplified</i> By Capt. Peter V. O'Rourke	Radio University 54 <i>Questions Answered</i> By Radio World's Technical Staff

Vol. XXVII, January, 1936. No. 12. Whole No. 688. RADIO WORLD, published monthly by Hennessy Radio Publications Corporation, 145 West 45th Street, New York, N. Y. Editorial and executive offices, 145 West 45th Street, New York, N. Y. Executives of RADIO WORLD: Roland Burke Hennessy, editor and business manager; Herman Bernard, managing editor; Herbert E. Hayden, advertising manager. Officers of corporation: Roland Burke Hennessy, president-treasurer; Roland Burke Hennessy, Jr., vice-president; Herman Bernard, secretary. Entered as second-class matter March, 1922, at the Post Office at New York, N. Y., under Act of March 3d, 1879.

SUBSCRIPTION RATE

Price 25 cents per copy. Subscription \$2.50 per year (12 issues), postpaid in United States and Possessions; \$3.00 per year postpaid in all other countries. Remittance for foreign subscription should be by International money-order (postal or express) or draft against or discountable at New York bank.

RADIO WORLD is distributed by the American News Company and its Branches

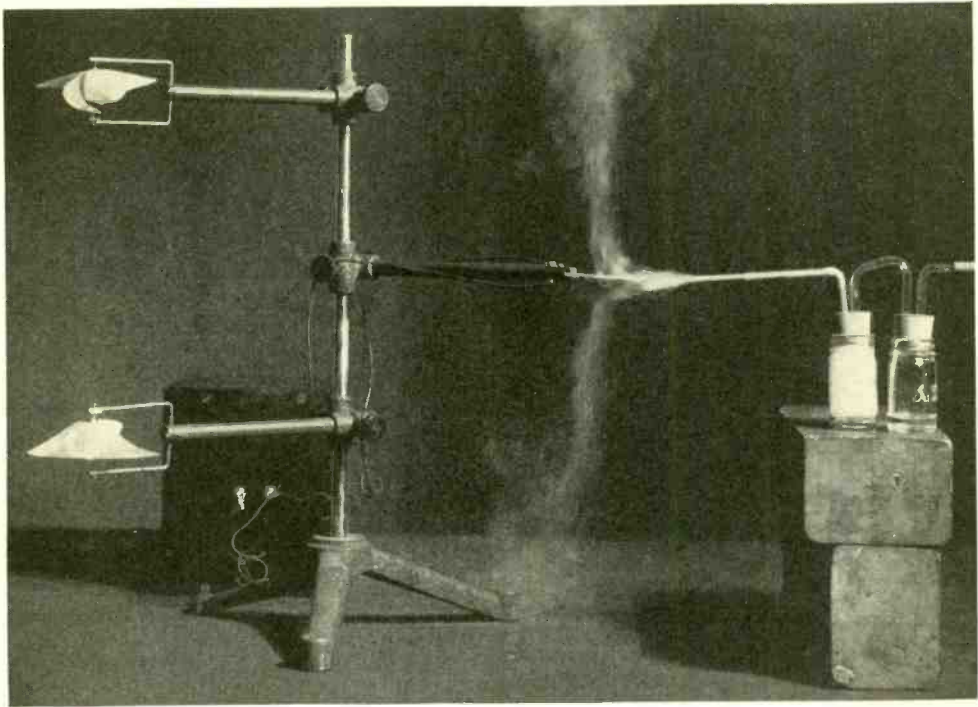

Wind from Quartz Crystals

Mechanical Vibration Sets Up Appreciable Air Current

By S. C. Hight

Radio Research, Bell Telephone Laboratories

IN recent years quartz crystal plates have come into wide use as frequency stabilizers for high-frequency radio systems. Such plates exhibit the piezo-electric effect in having an interlinked electric and mechanical vibration: if an alternating electric potential is applied across opposite faces, the crystal will vibrate mechanically, and conversely a mechanical vibration produces an alternating electric potential on opposite faces. The frequency at which the plate vibrates depends primarily on its dimensions, although ambient conditions have some influence. The action of these quartz plates has been studied intensively in these Laboratories, and during the course of some of these studies experiments were made with the currents of air created by a crystal while vibrating. Currents are produced flowing away from each of the two opposite broad faces of a crystal. The effect is shown in the photograph at the head of this article, where smoke is employed to indicate the path of the air stream.

With one type of plate that is used for frequency control, the quartz crystal is cut so that the electric axis is perpendicular to the large area of the plate, as shown in Fig. 1.

Resonance occurs at a frequency equal to 2.86×10^6 divided by the thickness of the plate in millimeters. When an alternating potential of this frequency is applied to the opposite faces of the plate, the surfaces move alternately apart and together. The motion of each surface is thus analogous to that of a piston with large area and very small stroke—the number of strokes per second being very large.

Consider for example a plate five centimeters square and 2.86 millimeters thick. The natural frequency of such a plate is a million cycles per second, and experimental measurements show that the surface moves about 8×10^{-6} centimeters. From the area of the plate and the amplitude of the motion, it may readily be calculated that each stroke of the surface, considered as a piston, displaces approximately two cubic millimeters of air. Since the surface is making a million strokes per second, the total displacement, if accumulative, would be 2000 cubic centimeters per second. A vibrating plate yielding such a displacement would constitute a fair size pump if there were some

(Continued on next page)

(Continued from preceding page)

valve arrangement to prevent the air from flowing back as the surface receded.

As already stated such a surface does pump a current of air, and experiment shows that the quantity is just about that given by the above calculations. There must, therefore, be a valve action of some sort. While a completely satisfactory explanation has not yet been found, an analysis of the conditions at the surface indicates a likely cause of the action.

The molecules comprising the air have a mean free path, and thus an approximate spacing, of

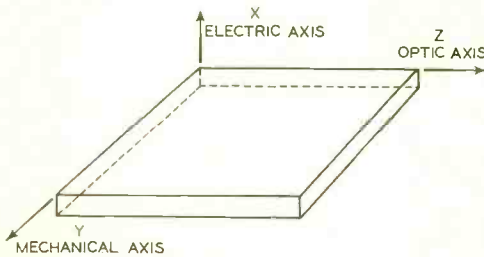

Fig. 1—An X-cut quartz plate has its electrical axis perpendicular to the face.

about 1,000 Angstrom units. Since the movement of the surface is approximately 8,000 Angstrom units, it moves through about eight layers of atoms. From the amplitude and frequency of the crystal vibrations it may be inferred that the surface of the plate reaches a maximum velocity of 500 centimeters per second, and to reach this high velocity in so short a time—a quarter of a millionth of a second—the acceleration must be some 20,000 miles per second. This is a tremendous acceleration. If it were continued for ten seconds the surface of the crystal would be a million miles away and moving with a velocity greater than that of light.

Under normal conditions the air molecules are moving in random directions with velocities slightly under 500 meters per second. As the crystal surface moves out, it gives to those molecules not already moving away from the face an outward acceleration of large value. As the surface of the crystal recedes, the kinetic energy imparted to the molecules forces them to continue in their outward directions, but molecules around the edges of the plate, which still have random motion, rush into the space made vacant. As the surface moves out on the next stroke, these molecules are in turn forced out, and the result is an essentially continuous stream of air flowing away from the faces of the crystal. This valve action is nearly independent of the frequency of vibration of the plate. Winds have been observed for vibrations as low as 50 and as high as 4,000 kilocycles.

To study these winds it is best to apply the electric field to the crystal by means of thin metallic films on the crystal surface. A coating of silver may be applied by the process used in making mirrors, or thin films of platinum or other metals may be applied by sputtering, or evaporation in a vacuum. These films are very

light and flexible, and—adhering to the crystal—move with the surface of the crystal in vibrating. Contact is made at one corner of the slab by a spring clamp, which also serves as a support for the crystal. The circuit used, shown in Fig. 2, is similar to the usual oscillator circuits that are employed for controlling the frequency of radio transmitters.

With a one-megacycle crystal of the dimensions considered above, the wind generated is sufficient to operate four-inch paper windmills placed on both sides of the crystal at a distance of a foot. The shape of the air stream can be studied by watching the action of the smoke. Turbulence is observed several feet from the crystal. The air stream has about the same cross-sectional area as the crystal for a distance of about a foot and then gradually becomes wider.

LITERATURE WANTED

Readers whose name and addresses are printed herewith desire trade literature on parts and apparatus for use in radio construction. Readers desiring their names and addresses listed should send their request on postcard or in letter to Literature Editor, Radio World, 145 West Forty-fifth Street, New York, N. Y.

- Joseph Salomon, Radio Laboratoire, 1218 Grand'Rue, Port-au-Prince, Haiti.
 Davis Radio Service, 817 West 34th St., Chicago, Ill.
 Karl J. Flor, W-9TNE, 3126-N. 27th St., Milwaukee, Wis.
 O. Ingmar Oleson, Ambrose Radio Service, Ambrose, North Dakota.
 Francis McAllan, 511 W. Prospect St., Angola, Ind., literature concerning radio parts.
 Alfred C. Eastman, W-1JFP, North Conway, New Hampshire, Amateur Call W-1JFP.
 H. H. Nathanson, 23 Tapscott St., Brooklyn, N. Y., auto radio.
 Sutherland Radio Shop, 1614 E. Grand Ave. Des Moines, Iowa.
 J. R. Love, 2012 Penn St., Harrisburg, Pa.
 Don MacPhedran, Jr., Snowden, Sask., Canada, literature concerning radio parts.
 John Pointek, 419 W. 17th St., New York City
 Raymond Schelshorn No. 1226, Box 51, Comstock, N. Y., (Xmitters and receivers, motion picture sound and P. A. systems.)
 Dan's Radio Service, 817 West 34th Street, Chicago, Ill.
 Superior Radio Service, M. J. Feigenbaum, 42 Jefferson St., Yonkers, N. Y.
 Supreme Radio & Electric Service, 2408 So. 3rd St., Philadelphia, Pa., especially new type tube testers utilizing good, fair, and bad meter scales, to test new 8-prong metal tubes.

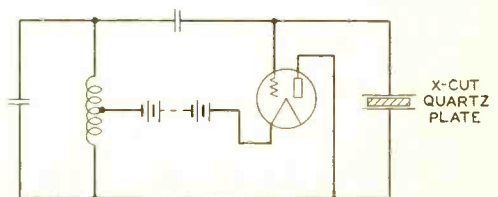
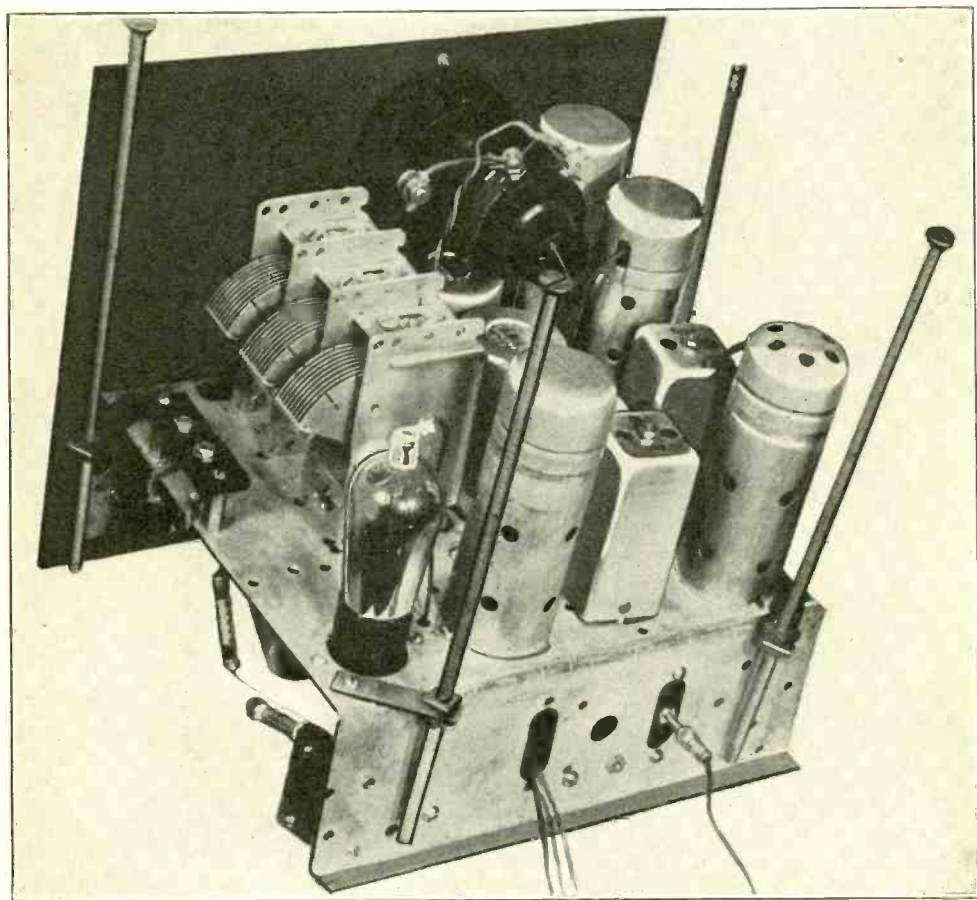

Fig. 2—Schematic of circuit used for producing crystal wind.

A "Hundred Channel" Super

Set for Boat or Home Uses D.C.

By John Braden



Rear view of Mr. Braden's five tube receiver. The four long bolts at the corners are merely temporary conveniences for holding the chassis upside down while wiring.

THIS five tube broadcast superheterodyne is intended primarily for use on a motorboat, and only secondarily for use in a home. When the circuit is used on a motorboat the filaments are connected in parallel across a six volt storage battery and the plate supply is a 250 volt motor generator driven by the same storage battery. When the circuit is used in a home the filaments are connected in series as they are in universal type receivers and the plate supply is either the filtered d.c. line voltage or the rectified and filtered a.c. line voltage. An

optional plate supply, of course, is a 135 volt B battery. The actual connection of the plate supply is not shown in the circuit diagram, but whichever type is used, the negative is connected to the chassis and the positive to the common lead joining all the plate returns.

A feature that deserves special attention is the thorough filtering and bypassing of the various leads. An engineer who has been contaminated with the ideas of low cost production of sets would undoubtedly contend that many

(Continued on next page)

(Continued from preceding page)

of the chokes and condensers are not vital, yet if that same engineer were to build a receiver for his own use he would, very likely, put them all in.

In the first two tubes there are individual cathode filters consisting of a 300 ohm bias resistor in series with a 2.5 millihenry choke, the two being shunted by a condenser of 0.1



The author tuning the receiver. He picked up a Mexican station early in the evening, without interference from local stations, with only an 8-foot wire for an antenna.

Close-up view of the rear of the tuning indicator. This consists of a 0-1 milliammeter shunted by a 6 ohm rheostat. The meter is connected in the plate circuit of the 6D6 i.f. amplifier and the shunt has been adjusted so that on no signal and the cathode resistance set at minimum, the meter reads full scale. As resonance is approached, the needle dips toward zero, being lowest at exact resonance. The strongest signal that is tuned in near the zero is the minimum reading.

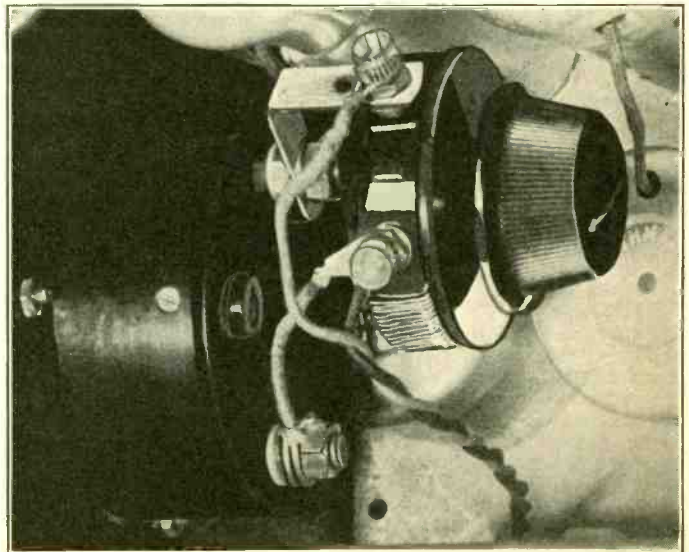

LIST OF PARTS

Coils

One antenna coil for 350 mmfd. condenser.
 One r.f. tuning coil for 350 mmfd. condenser.
 One oscillator coil for 175 kc r.f. and 350 mmfd. condenser.
 Five 2.5 millihenry choke coils.
 Two 175 kc doubly tuned r.f. transformers.
 One 1-to-1 audio output transformer.

Condensers

One three gang .00035 mfd. tuning condenser with trimmers.
 One 800-1250 mmfd. pad.
 Eight .1 mfd. Two 25 mfd.
 One .002 mfd. One .001 mfd.
 Two .0001 mfd. One .005 mfd.
 Two .05 mfd. One 8 mfd.

Resistors

Two 300 ohm. One 25,000 ohm rheo.
 One 800 ohm. One 2 meg.
 One 20,000 ohm. One 1,500 ohm.
 One 50,000 ohm. One 10,000 ohm.
 One 1,000 ohm. One 25,000 ohm.
 Two 100,000 ohm. One 15,000 ohm.
 One 1 meg. One 6 ohm rheo.
 One 0.5 meg. One .25 meg.
 One 15,000 ohm pot.

Other Requirements

Five tube sockets, One 0-1 milliammeter.
 wafer type. Ant.-gnd. terminals.
 Five control knobs. One output terminal strip.
 Four grid clips. One airplane type dial.
 One chassis.
 Three tube shields.

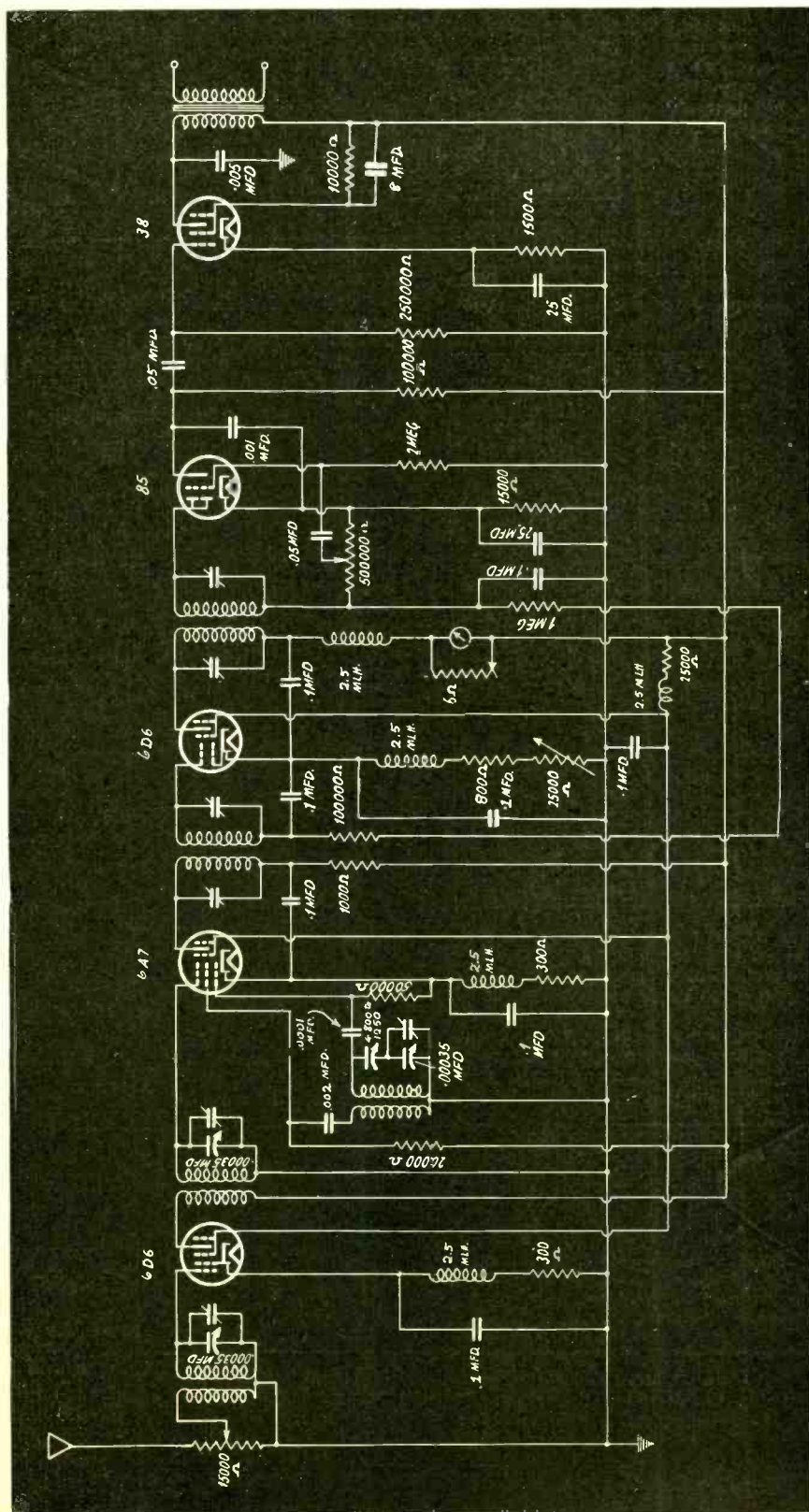

Excellent performing super. It is free of image interference as well as direct station interference, and it has good output quality. Note: The .1 mfd. condenser now connected between ground and the negative end of the load resistance should be connected to the opposite end of the one megohm stopping resistor.

(Continued from page 8)

mfd. A similar filter is used in the cathode circuit of the 6D6 i. f. amplifier, except that the bias resistor consists of two parts, a fixed 800 ohm resistor and a variable 25,000 ohm resistor.

Cathode Filtering

In the cathode lead of the 85 triode is a 15,000 ohm bias resistor and this is shunted by a 25 mfd. electrolytic condenser. In the cathode lead of the 38 power tube is a 1,500 ohm bias resistor shunted by a similar electrolytic condenser. The very large values of by-pass

such that the high notes would be strikingly missing and that the low notes would predominate. For example, there is a .001 mfd. bypass condenser in the plate circuit of the 85 and a .005 mfd. condenser in the plate circuit of the 38. Ordinarily they would be so high that the high audio notes would be depressed considerably. It must be remembered, however, that the effectiveness of a bypass condenser depends not only on its capacity but also on the resistance across which it is connected. In this case the .001 mfd. condenser is connected across two resistances in parallel, the output resistance of the 85 and the load resistance, each of which is comparatively low

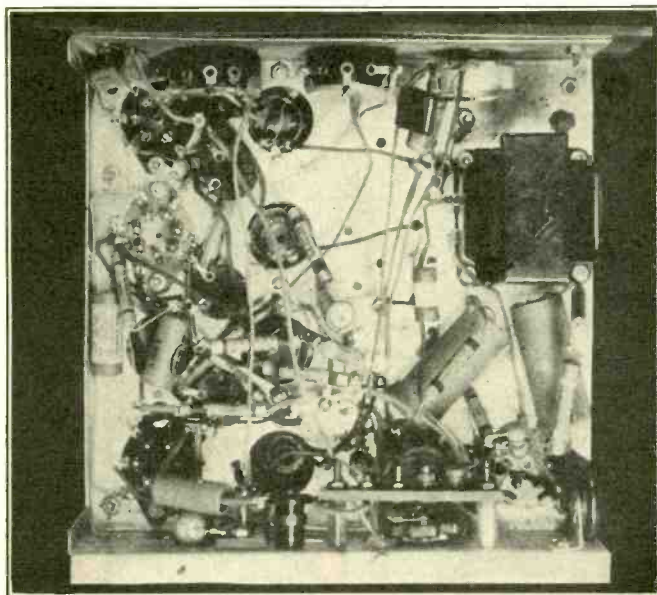

At 7:45 p.m., in N. Y. City the author tuned in a Mexican station without any interference from the local stations. This is a severe test of selectivity for any set for at that time of the evening all the local stations are going full blast and remote stations do not come in with their best strength. Incidentally, Mr. Braden reports that there is a clear station at almost every division of the dial. That means not only high selectivity but high sensitivity. Bottom view of the set is shown.

condenser, of course, are used to prevent degenerative effects on the low audio frequencies. The cathode filtering in the high-frequency tubes is done for similar reasons. There is also extra filtering in the grid, plate, and screen leads which aids in stabilizing the circuit.

Only one tube, the 6D6 i. f. amplifier, is put on the a.v.c. Note that the grid of this tube returns to the cathode of the 85, and therefore to a point that is considerably positive with respect to ground, whereas the cathode of the i. f. amplifier is connected to ground, through the bias resistor. It is because of these connections that the grid bias resistance for the 6D6 is so high—a minimum of 800 ohms and a maximum of 25,800 ohms. This high value is to insure that at no time the grid of the 6D6 shall go positive.

Audio Response

At first glance it would appear that the values used in the audio-frequency circuits are

in value. Therefore the large bypass condenser is not excessively effective on the high audio notes.

Response from Every Channel

The gain on the low audio notes is well provided for because each of the two series condensers has a value of 0.05 mfd., which are unusually large values, and very large bypass condensers are used across the bias resistors, as has already been pointed out.

The separation between adjacent broadcast channels is also satisfactory. Thus WLW can be received in New York City without interference from WOR, a powerful local station only 10 kc removed from WLW. A more severe test will scarcely ever be required. Of course, the channel-to-channel separation is practically the same at all parts of the broadcast band because it is determined primarily by the selectivity of the six tuned circuits in the intermediate selector. It was possible therefore to get a response from every one of the hundred broadcast channels.

A Battery Transceiver

Room Below for the Power Supply

By Max Steir

Radio Constructors Laboratories

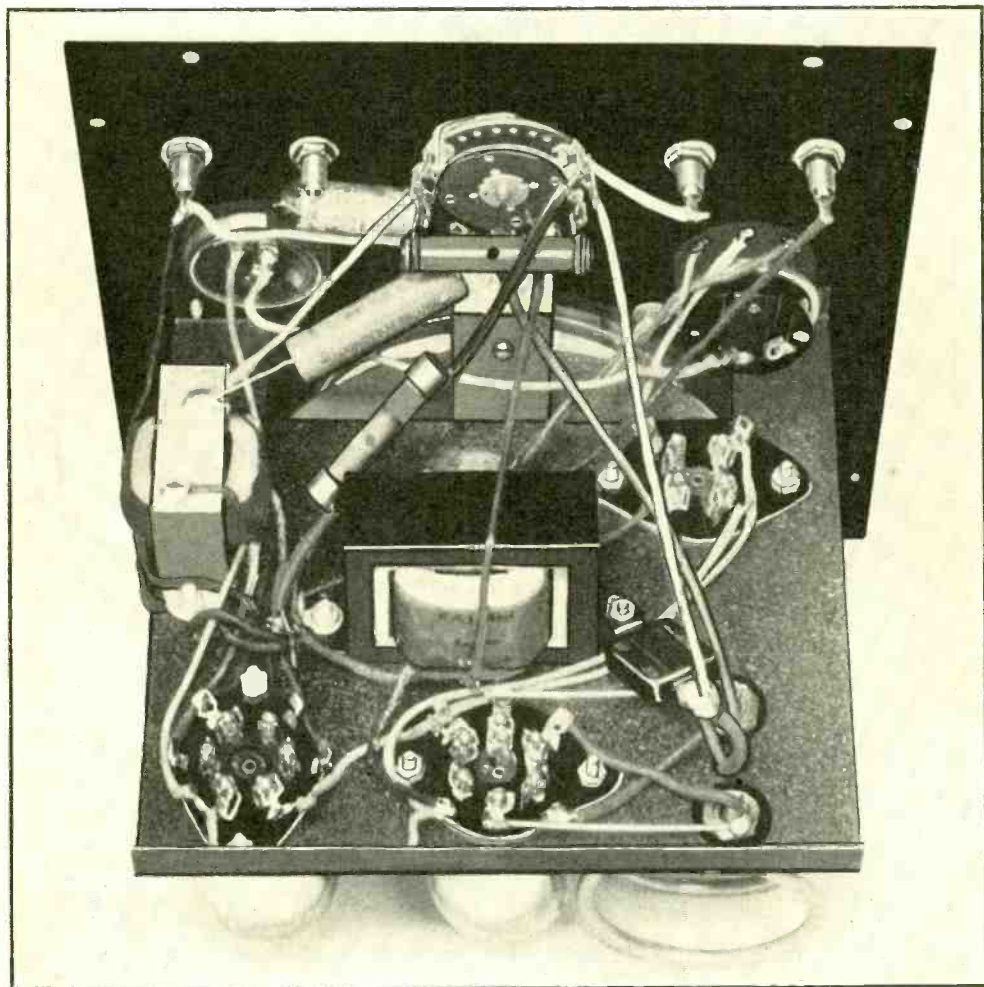

When the transceiver chassis is turned upside down, it looks like this. At the top of the picture are the tip jacks for the phones and the microphone and also the gang switch. Two of the audio transformers are mounted under the chassis and small fixed condensers and resistors are scattered about in a manner characteristic of point to point wiring.

ULTRA short wave circuits are about as simple as a circuit can be. They are, in fact, simpler than crystal and one tube broadcast receivers used to be. The simple layout picture here is a complete transceiver. It consists of three tubes, a small tuning condenser, a special two turn coil, three audio transformers and a few small parts.

Two of the tubes are 19's, one an ultra high the oscillation transformer is said to have unity radio frequency oscillator of the push pull type and the other a push pull audio power amplifier. The third tube is a 30 type audio amplifier.

The inductance coil that is used for both transmission and reception consists of two turns

(Continued on next page)

(Continued from preceding page)

of $\frac{3}{8}$ inch copper tubing with two inch inside winding diameter. The coil is wound on air, for the tubing is so rigid that no support is necessary. The grid coil is wound inside the plate coil tubing. Because of this construction coupling. It may not be exactly unity but it is very close to it. Very tight coupling between the grid and plate coils of an oscillation trans-

former is one condition for frequency stability, an important consideration in an ultra high frequency oscillator.

Bringing Out Tap

Since the grid coil is tapped at the center point for the grid return, it is necessary to

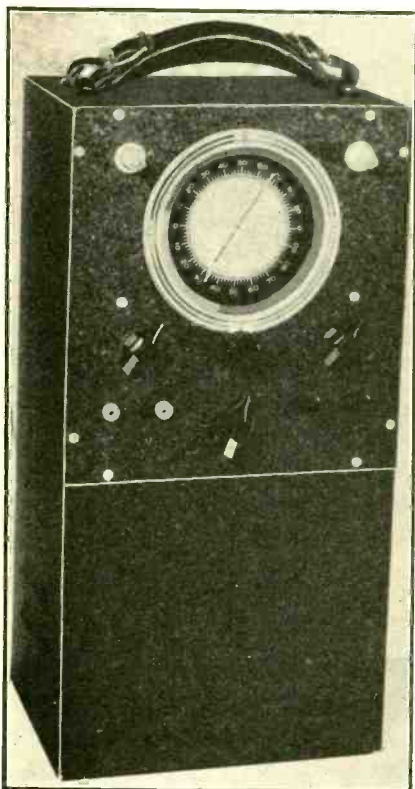

Batteries go in the nether compartment.

LIST OF PARTS

Coils

- One special two turn oscillator coil made of hollow copper tubing.
- One push pull output transformer for 19 type tube.
- One push pull input transformer to work between a 30 and a 19.
- One special three winding input transformer for microphone and tube input.

Condensers

- One three plate air condenser with both sets of plates insulated.
- One .0001 mfd. mica.
- One .01 mfd.

Resistors

- One 7,500 ohm grid leak.
- One 3 megohm grid leak.
- One .5 meg. potentiometer.

Other Requirements

- One three pole double throw switch.
- Three wafer type sockets.
- Three bar type knobs.
- Two pairs of tip jacks for phone and microphone.
- One 90 volt B battery.
- One 3 volt filament battery.
- One large airplane type dial with escutcheon.
- One chassis
- One carrying case.

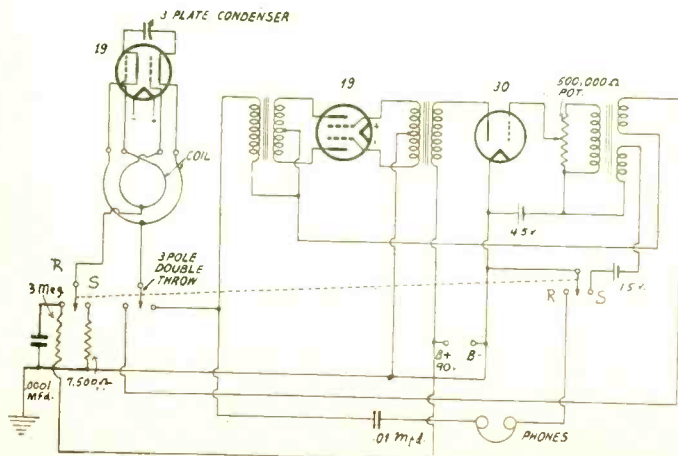

The circuit of the three tube transceiver. The plate return of the 30 connects to the first horizontal line and does not jump it as shown in the diagram. Without this connection the two 19 tubes would not get any plate voltage. Note the connection of the three plate condenser from plate to plate of the oscillator tube. The circuit is therefore of the tuned plate type and it is also push-pull.

bring this tap out of the plate coil tubing. This is done by drilling a hole in the tube at the center. Good insulation is essential at the point where the grid wire is brought out. The "goodness" refers mainly to its mechanical properties because the electrical requirements at this point are not very strict. The voltage between the

quency tube is delivered to the 30, which feeds the push pull audio in the usual way. The audio volume is controlled by means of a .5 meg. potentiometer in the grid circuit of the 30 tube. In the R position this controls the sound power delivered to the phones and in the S position it controls the degree of modulation

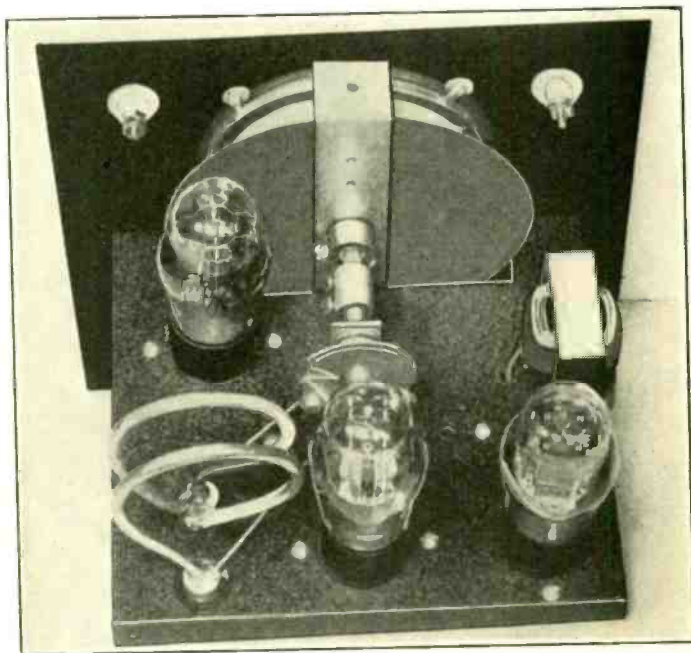

Rear top view of the three tube transceiver. In the left front corner of the picture is the unity coupling coil and in the center of the chassis is the small three plate condenser that tunes it. The oscillator tube is on the right of the coil. One of the audio transformers is mounted on top. as are the 30 and the audio 19 tubes. Notice that a very large dial is used to tune the tiny condenser.

two coils is low and because of the balanced circuit there is practically no r.f. voltage between the two center points.

The coil dimensions given above are for a five meter oscillator.

The circuit shown is a transceiver, that is, it may be used either as a transmitter or as a receiver. It is changed from one to the other by throwing a triple pole, double throw switch. When the switch is in the S position the circuit is a transmitter and when it is in the R position it is a receiver. In the S position a 7,500 ohm grid leak is connected between ground and the center of the grid winding and the center of the plate winding is connected to the output of the push pull audio amplifier. This in turn is fed by the 30 amplifier, which is fed by a microphone connected in the primary of the input transformer.

How Modulation Arises

Since the audio output of the 19 amplifier is in series with the plate voltage, the oscillator is modulated by varying the voltage applied to the plates of the tube. In the R position a 3 megohm grid leak is in the grid circuit of the 19 oscillator. This grid leak is connected to 90 volts plus. The output of the high fre-

quency tube is delivered to the 30, which feeds the push pull audio in the usual way. The audio volume is controlled by means of a .5 meg. potentiometer in the grid circuit of the 30 tube. In the R position this controls the sound power delivered to the phones and in the S position it controls the degree of modulation

Microphone Insert

The position of the microphone is not indicated in the circuit diagram, but it should be in series with the lower of the two right hand winding on the input transformer. The batteries in series with the microphone loop supply the polarizing current for the carbon transmitter.

Notice that the grids of the audio 19 are returned directly to ground. This is possible in an audio power amplifier because this particular tube has been designed especially for Class B amplification with zero grid bias.

Colpitts with One Variable

IN the Colpitts oscillator a two gang condenser is used, the capacities effectively in series. May not a single variable be used, the other capacity fixed?

It is possible, but the series fixed capacity must be small compared to the maximum of the variable, hence the frequency range small. Otherwise at high capacity settings of the variable the voltage drop across the fixed capacity would be too great. In effect, then, the circuit would stop oscillating.

A Slideback Tube Voltmeter

Battery Circuit May Be Built for External Meters

By Jack Tully

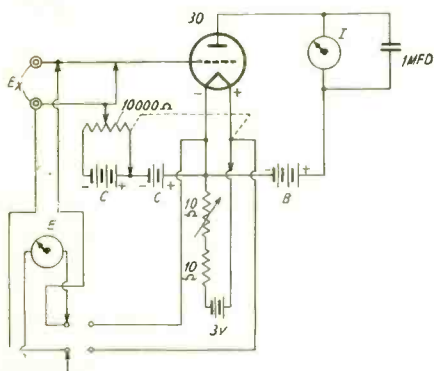

Circuit for a slideback type of vacuum tube voltmeter, that measures a.c. voltages correctly, regardless of frequency, and which may be used also to measure d.c. voltages, in both uses under conditions of no current being drawn by the measuring circuit.

THE simplest vacuum tube voltmeter is one that does not require any calibration, since a d.c. voltmeter is used, which is already calibrated. The principle of operation is that a vacuum tube is used, with voltage supplies, so that the plate current is reduced to give zero reading on a plate milliammeter. Then the unknown a.c. is introduced between grid and cathode and the plate needle deflects accordingly. Next, more negative biasing battery voltage is introduced until the plate current is restored to zero. The d.c. voltage additionally introduced, as which is measured on the d.c. voltmeter, is equal to the peak a.c. voltage of the unknown. The instrument is called a slideback vacuum tube voltmeter.

Since the major requirements have to do with measurements of small values of voltage, in a nonreactive system, under conditions where no current is drawn by the measuring device, the circuit shown will fulfill the conditions.

How to Find R.M.S. Voltage

The peak a.c. voltage usually is not desired, but the root mean square value may be calculated from the peak. The r.m.s. is equal to .707 of the peak voltage.

The d.c. voltmeter used is naturally of the current drawing type. But no particular precaution is necessary, so long as the potentiometer resistance is small compared to the series resistance built into the voltmeter. As

most persons have a voltmeter of 1,000 ohms per volt sensitivity, it may be connected to the circuit when desired, and not built in as an integral part of the instrument. The scale should be as close as possible to the range of the VTVM, hence a range of 0-5 for meter E would be suitable, and a range of 0-3 would be best. Ranges from 0-3 to 0-6 volts may be used, for 45 plate volts, 4.5 volts negative fixed bias.

The milliammeter will give a cutoff reading regardless of sensitivity of this instrument, but cutoff is a little bit of a problem, and besides the current meter, I, should reach approximately full scale when the maximum a.c. voltage permissible is put into the unknown terminals, EX. The applied d.c. voltages will have much to do with this as well as with the range. By increasing the voltages the range can be increased, even to values up to nearly 20 volts of unknown, but 180 plate volts would be required.

The Negative Bias Rule

In general, the rule for the 30 tube is that the negative grid bias required for cutoff of plate current is about equal to one-tenth of the B voltage applied. So the fixed biasing plate supply for what may be considered minimum plate supply of 45 volts is 4.5 volts. If the needle does not come exactly to zero on the meter I, then the point at which it comes to rest, which is close to zero, is noted, either by remembering it, or by marking the meter scale at that point. A little better accuracy may be established this way, because then one avoids the peril of a false zero current position.

The plate current is never cut off, is never zero, since when there is a voltage across a resistance there is current through the resistance, but what passes for zero current or cutoff is the needle position indicating no deflection, either positive or negative. It is of course possible to get a small positive deflection this way, as already pointed out, but it is also possible with many meters to have the needle go below zero, and this particularly is to be avoided.

A fair test if one is operating at intended zero or so-called cutoff is to adjust the meter I for zero reading when the circuit is inoperative, and then apply the A, B and C voltages, excepting the adjustable C voltage, to determine whether the needle position changes in any slight degree.

Filament Voltage

If it does, the zero operating point does not exist in reality. In that case, see that there is

a small deflection, if need be by adding or subtracting B voltage, as by putting a 1.5 volt cell in series aiding or series opposing with the B battery, or use for datum point some small positive deflection.

It is well to have the limiting network in the filament circuit consist of a fixed resistor and a variable, so that the applied voltage will be just 2 volts on the filament. The rheostat will enable this adjustment. A switching arrangement permits the voltmeter to be connected across the filament to establish the needed reading, which is taken just before the device is to be used for measurements. The d.c. voltmeter should draw small current compared to the filament current, but this condition will actually exist anyway, since a voltmeter drawing current equal to the filament would have a resistance of only 16 2-3 ohms per volt. Hence a meter of a resistance of several hundred ohms per volt, for full scale deflection of a voltage position of 5 or 6 volts or so, would be very satisfactory, and a meter of 1,000 ohms per volt would be splendid.

Operational Steps Tabulated

The operation is as follows:

First, the zero adjusters of the plate current and d.c. voltage meters are set for true zero, without the circuit being operative.

Second, the unknown terminals are shorted.

Third, the double pole double throw switch is turned to the right (again referring to the diagram) to measure the filament voltage, which is done with external d.c. voltmeter connected to its posts. Then this meter is switched to the left to read the additional biasing voltage, which now is reduced to zero.

Fourth, the slider is moved all the way to the left, so that as much as possible of all the biasing voltage is introduced.

Fifth, the short is opened at the unknown

terminals and the unknown a.c. is introduced. There should be small if any plate needle deflection before one proceeds.

Sixth, the slider is moved back to the right, all the way, to remove the additional biasing voltage, slowly, however, to be sure that the plate needle does not come any way near full scale deflection, as further movement of the slider might put more current through the meter than is safe.

Seventh, the deflection of the plate current meter is noted carefully, the unknown is removed and the d.c. meter is quickly switched across the grid circuit and the slider moved to the left until the plate current is restored to the reference point, which may be zero or slightly above zero, as you prefer, although always the same point will be used. The d.c. voltmeter reading that produces this condition is noted and is equal to the peak a.c. voltage, as already explained.

Must Use Two Meters

Two meters are needed, as both have to be in service at the same time, but instead of only the voltmeter being external, the plate meter may be likewise, and therefore the instrument may be built up without any meters in it using three sets of posts. Two sets are for the meters and the third set is for the unknown.

The range is 0-3 volts r.m.s. under described conditions.

The handle at the top of the coil can in the left figure at the bottom is for the purpose of close adjustment of the tuning of the beat oscillator. The method of reaching the condenser inside the can is illustrated in the middle photograph. A rod is attached to the condenser and is brought out at the top of the can. The handle is attached to the upper end of this rod.

With a slideback tube voltmeter it is practical to read the a.c. (signal) plate voltage of a small generator like this, but not usually the a.c. grid voltage, as that normally is higher than the plate a.c. voltage, due to cutoff during part of the alternation.

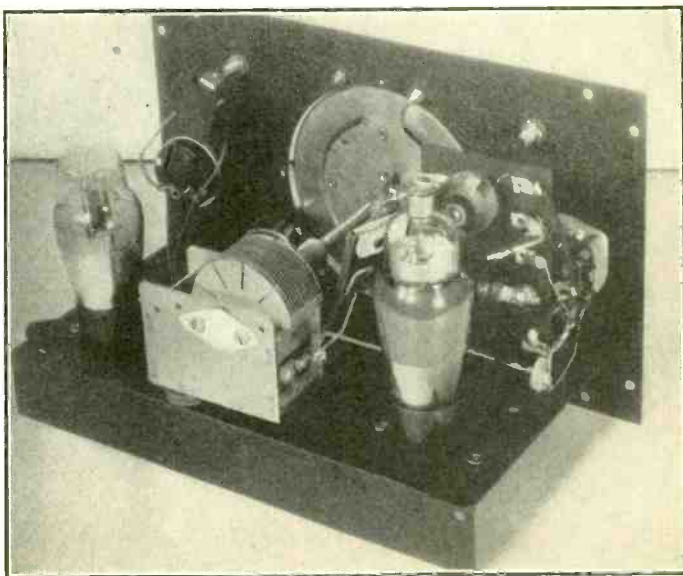

A PORTABLE PHONOGRAPH AMPLIFIER

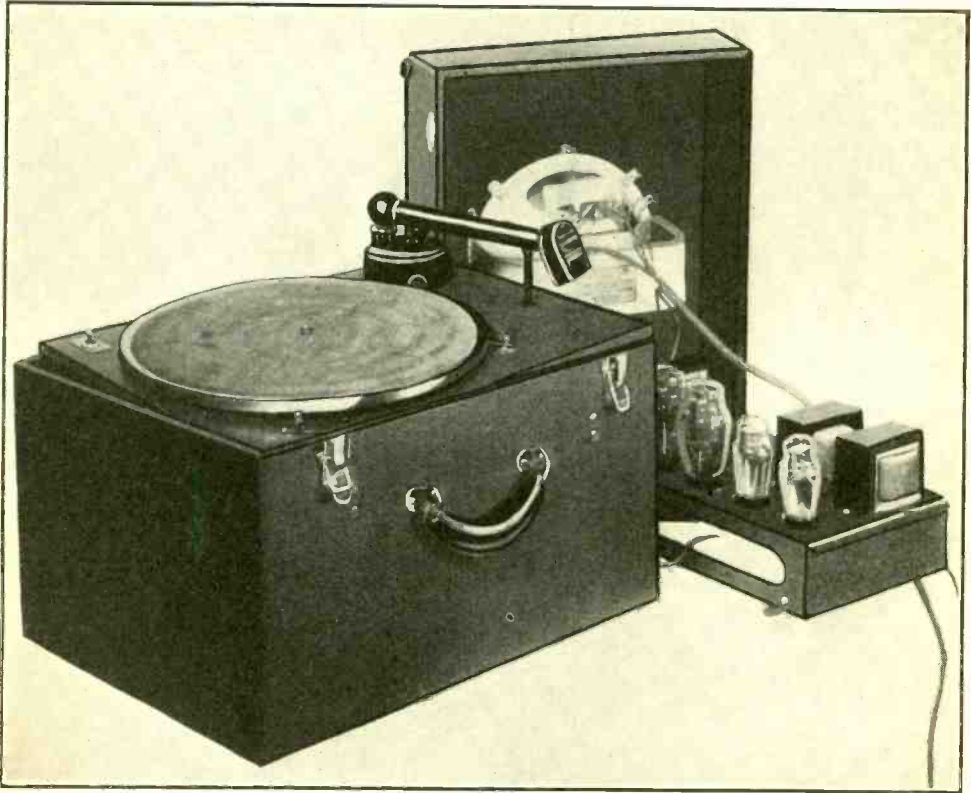

An a.c.-d.c. turntable and a high impedance pickup constitute one unit—the amplifier, power supply and speaker the other—in this "universal" design. The power amplifier circuit is below.

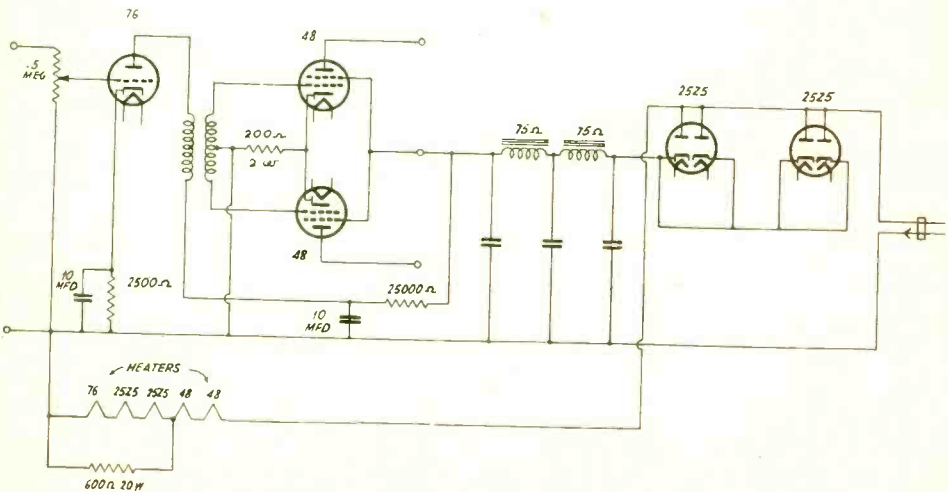

How the unit shown at right in the photograph is wired. The filter condensers are 8 mfd. each.

The Bank Wound Coil

Shows Higher Broadcast Q Than Solenoid

By Edward M. Shiepe

Delta Radio Company

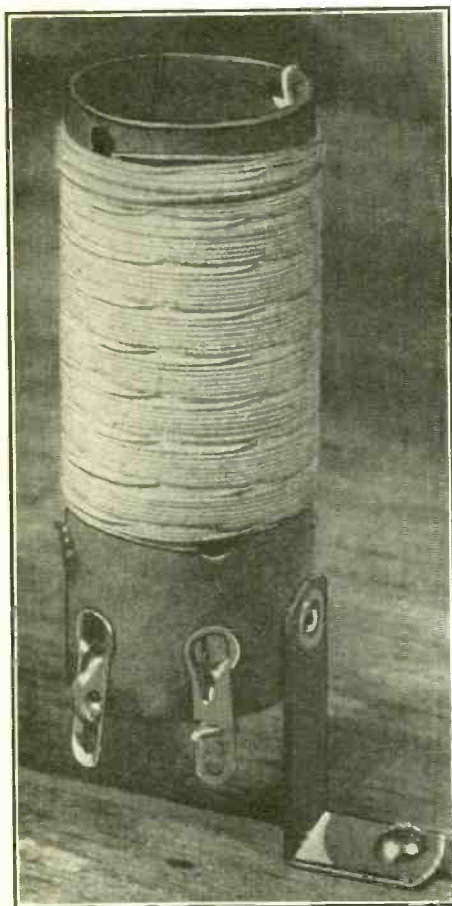

Bank wound coil of 228 microhenries that showed up better than a solenoid. Both were commercial coils.

BOOKLET ON DISC RECORDING

Universal Microphone Co., Inglewood, Cal., has issued its 1936 illustrated edition of "Advanced Disc Recording," by E. E. Griffin, chief engineer. (10c). One section is devoted entirely to 33 1/3 r.p.m. recording. All methods are described in detail and there are separate pages on recording on aluminum, Silveroid or acetate. The cutting head, recording amplifiers and other topics are discussed.

A RAPID method of relative determination of the effectiveness of a radio frequency coil is to note the amplitude of the input to a vacuum tube voltmeter when an oscillation frequency is fed to the unknown coil, across which is put a condenser to tune the coil to the oscillation frequency. The unknown is the load on the VTVM grid. If comparison is to be made among numerous coils, the best coil would be the one that showed the maximum change of needle position, that is, built up the highest r.f. voltage. It is assumed the coupling is the same for all coils tested, and is provided in the measuring circuit.

If the tube voltmeter is of the cutoff type, the a. c. may be applied, the needle will deflect, and then a d. c. voltage may be introduced to buck the a. c., restoring the needle to zero position, and then the peak value of the a. c. is equal to the d. c. voltage required to restore the needle to zero. Then the actual voltage developed across the coil is known. The higher the voltage the better the coil.

How They Compared

Some tests of broadcast coils, including bank wound and solenoid types, were made and the bank wound coil showed a current deflection on a 0-1.5 milliammeter of 1.52 while the solenoid showed 1.32. Since the solenoid is one of the best coils, naturally it is interesting to find that the bank wound coil showed up superior by this test.

The voltage measurement, or determination in relative values, is a ready one, but not complete and definitive. All the factors are present, but are masked, so that one may decide that the coil producing the highest voltage has the highest Q, but one does not know what the Q equals, and there may be confusion because the Q change is not linear. Frequency, inductance and radio frequency resistance enter into the determination of the Q.

Nevertheless, the comparison just mentioned shows up the bank wound coil favorably. As single winding it may be considered the best commercial coil for broadcast frequencies.

Inductance Tabulation

The bank wound coil illustrated has an inductance of 228 microhenries. Only the secondary was tested. There was a primary consisting of a r.f. choke coil, universal wound. For antenna coils this primary has 1.92 millihenries inductance and for r.f. coils (interstage) 3.5 millihenries. The two-layer secondary

(Continued on next page)

Recording and Playing Back

Quality System Costs No More Than Good Receiver

By M. N. Beitman
Allied Radio Corporation

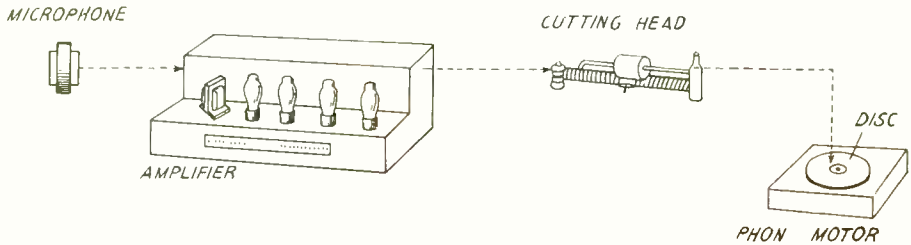

The recording process.

IT is possible for anyone to make excellent recordings easily and inexpensively. A modern complete recording system as shown proved remarkable for its successful results and its simplicity of operation. You will undoubtedly be surprised to find that an excellent system of this type can be had at less than the cost of a good receiver.

In planning this recording system the various methods that have been used to record sound were carefully considered. The disc method is the only practical method for non-professional

recording. While either pregrooved or blank discs may be successfully used, blank discs make superior records, reproducing with better fidelity than the pregrooved type. Consequently, this inexpensive recording system incorporates a lead-screw recording head for use with blank aluminum records.

Principles of Recording

The entire process of recording is based on a few simple principles of electrical and acoustical (Continued on next page)

Inductance Tabulated for Bank Winding

(Continued from preceding page)

was wound with 10-strand No. 41 single cotton enamel Litz, on $\frac{7}{8}$ -inch diameter. The primary was not inductively coupled, but two turns leading from it, put around the secondary, afforded 13.7 mmfd. capacity coupling.

For this tubing the number of turns of the secondary wire and the resultant inductance are shown herewith:

Number of Turns	Inductance (Microhenries)
165	275
160	261
155	254
145	247
140	238
135	229
130	218
125	207
120	198
115	188
110	175
100	169
95	156
	148

The bank wound and the solenoid coils were

measured at 600 kc, detuning was done on one side only, the VTVM plate currents at resonance were as already stated, while for halving the current, the solenoid required an increase of 14 kc and the bankwound coil an increase of 16 kc. Ordinarily, the more the frequency has to be increased or decreased to halve the current the higher the r. f. resistance of the coil, but here we have interposed the characteristic of the VTVM, a 955 triode acorn, and have not started with equal values of plate current that is, comparison is for unequal voltages.

So although the plate current is an indication of the value of the coil, if the effect of curvature of the tube characteristic is eliminated, as by the slideback voltmeter test, the frequency difference required for the bank wound coil would be less than 14 kc.

It should be noted the r.f. voltage or current was not halved but only the plate current was. The radio frequency resistance of coils, an important consideration, though encompassed in the Q, may be measured by introducing series resistance in the coil to halve the a.c. current. The introduced resistance equals the coil's resistance.

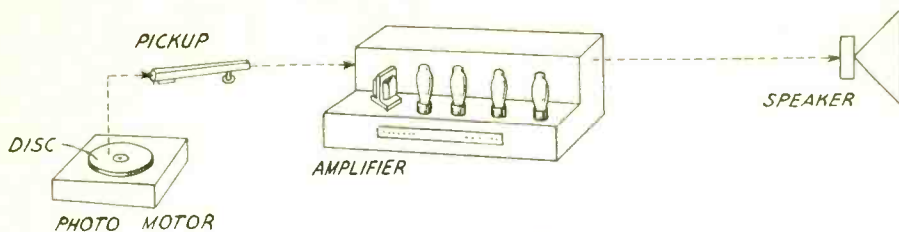

The play-back arrangement. Phono motor is at left.

(Continued from preceding page)

cal sciences. Briefly, the sound, be it conversation, music or singing, is changed from sound energy to electrical energy. A double button carbon microphone, with good frequency response, may be used for this purpose. The sound coming from the microphone emerges in the form of electrical energy and is transmitted to a quality 10 watt high gain amplifier. The object of this amplifier is to amplify or build up the weak electrical energy coming from the microphone to an intensity sufficient for the creation of brilliant records.

The output of the amplifier is fed to a recording head of the screw feed type. This output, of course, possesses the electrical characteristics of the original sound in electrical form, but it has been considerably amplified.

Head Cuts Groove

As the disc revolves, the cutting head cuts a groove and at the same time the needle moves from side to side responding to the original sound characteristics. In this manner a record of the sound is made on the disc, as in the first figure.

The entire process may be briefly summarized in terms of the stages through which the sound passes. First, the microphone changes the acoustical energy of the sound to electrical energy. This electrical energy is fed into the amplifier where it is increased to an intensity needed to operate the recording head. The recording head then changes this electrical energy to mechanical energy and records it on the disc.

In order to reproduce the recorded sound, the process is simply reversed.

Purpose of Pickup

A pickup arm is used to convert the recorded sound to electrical energy. This, in turn, is fed to the input of the same amplifier (which is, however, connected somewhat differently than in the recording process), and from the amplifier to a dynamic speaker which changes the increased electrical energy back to acoustical energy, that is, to the original sound. See second figure for illustration of play back process.

The essential equipment required for the type of system described, is listed below. It represents the simplest and the lowest-priced system capable of making excellent records of the type that you will be proud to make and play for your friends and customers.

Essential Parts for a Low-Priced Recording System

- 10 watt, 3 stage amplifier.
- Dynamic speaker.
- 2 button microphone.
- Microphone stand.
- Electrical dual phonograph and pickup.
- Recording head and lead screw.
- Microphone cable
- Speaker cable
- Control box.

Accessories

- Sapphire recording needle
- Package of 50 fibre reproducing needles.
- Aluminum blank discs for recording.

Used as a P.A.S.

These parts may be obtained from well-known radio distributors.

A very important feature of the design of this recording and playback system is that it is also easily adaptable for use as a powerful, high quality public address system. It is at once apparent that the applications of a dual recording and public address system for both entertainment and money-making purpose are unlimited.

The market for recordings is enormous and is growing steadily as persons become familiar with the successful results which are now inexpensively attainable. Orchestras are now being recorded so that they can study and improve their techniques. Students of music make records as a regular part of their training. Records are in demand for "sound effects" in radio and amateur theatrical productions. Thousands of records are being made for advertising purposes for home entertainment, for use with home movies, for certification of short wave program reception and for hundreds of other applications.

In the public address field, the 10 watt system may be profitably and successfully used for amplification in chapels, halls, ballrooms, and for orchestras, window demonstrations and lectures.

Wooden Cabinet Provides Better Tone for Portable

In constructing a portable set it is better to use a wooden box than a metal one, because the wood affords better tone, due to superior baffling. At best, the baffling will not be all that could be desired.

A Metal Tube T.R.F. Tuner

Four Gang Condenser in Stable, Sensitive Circuit

By J. E. Anderson

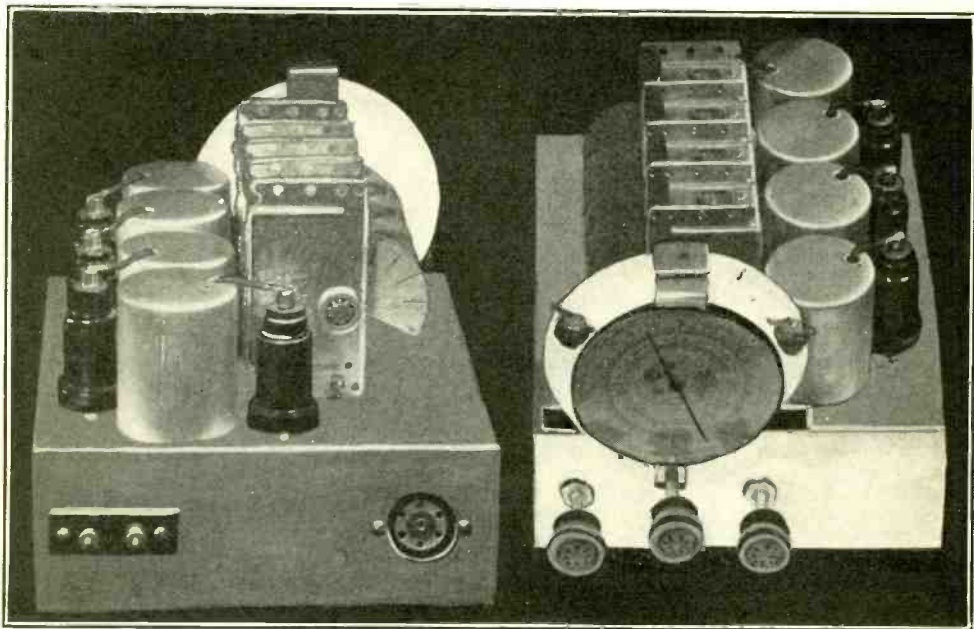

The left picture shows the rear, the right picture the front, of the four-tube radio frequency tuner. The layout is clearly indicated.

THE discovery that audio frequency amplifiers which have been designed especially for public address purposes are, in most instances, capable of a much greater output and better quality than the audio amplifiers usually incorporated in radio receivers has created a demand for so-called radio tuners, or receiver "front ends." These are to contain all the elements of a complete radio receiver except the audio amplifier and the speaker, and possibly the power supply. They are to perform the functions of station selection, radio frequency amplification, detection and volume control.

The "front end" may be either of the tuned radio frequency type or the superheterodyne type. Regardless of the type demanded, however, the "front end" must be reasonably sensitive, sufficiently selective, simple to operate, as free of noise as possible, and up-to-date.

Use of Metal Tubes

If the "front end" is to be strictly up-to-date it should be designed around the new metal tubes, for they are the latest. Modernity, however, is not their only recommendation. They have many advantages over the older glass

tubes. First, they are small and lend themselves to compact and efficient circuit layouts. Second, they are self shielded and thus do not require any bulky external shields. Third, they are more efficient and take less power from the line. Fourth, they are rugged and not easily damaged. For these reasons metal tubes will be used in the "front end" to be described below.

High fidelity and tuned radio frequency amplification are inseparable ideas in the minds of most radio listeners, and many of the fortunate owners of public address amplifiers are among the majority. Therefore the "front end" to be described will be of the tuned radio frequency type.

As will be seen from the diagram of the circuit, the tuner contains four metal type tubes, three 6K7's and one 6J7, and four tuned circuits.

Control of Volume

These four circuits are tuned with a four gang variable condenser in which each section has a maximum capacity of 365 mmfd. The

(Continued on page 22)

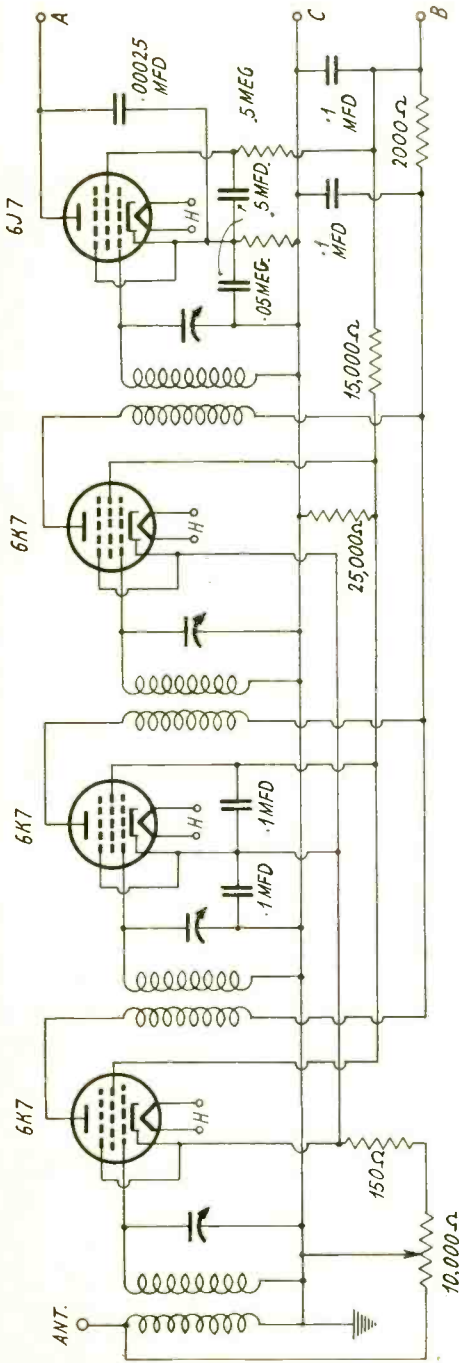

Resistors

- One 10,000 ohm tapered volume control
- One 150 ohm
- One 50,000 ohm
- One .5 megohm
- One 25,000 ohm
- One 15,000 ohms, 2 watts or more

Other Requirements

- One chassis
- One large airplane type dial with two pilot sockets
- Three control knobs
- Four miniature grid clips
- Four wafer type octal sockets
- One wafer type six-contact socket
- One antenna and ground binding post strip
- One line switch
- Three 6K7s and one 6J7 metal tubes

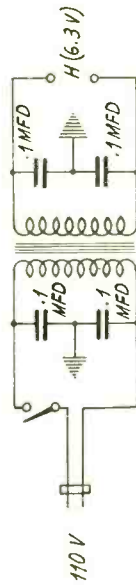

LIST OF PARTS

Coils

- Two shielded r.-f., high selectivity transformers for 365 mmfd.
- One 6.3 volt filament transformer

Condensers

- One four gang, 365 mmfd., with trimmers
- One .00025 mfd. mica
- Two (or three) dual 0.1 mfd., 200 volts or higher
- Two .5 mfd. by-pass condensers, 200 volts or higher
- One .1 mfd. condenser, 400 volts or higher

(Continued from page 20)

coils used are of the solenoid type, the primary winding in each coil being wound over the low potential end of the secondary. The coils, of course, are enclosed in metal shields. It is not practical to use the so-called high-gain coils in this circuit because of the enormous amplification afforded by the 6K7 tubes. The best compromise between selectivity and sensitivity is obtained with the shielded solenoid coils of relatively low gain.

The output of the tuner is controlled by varying simultaneously both the gain and the input voltage, and the gain is controlled by means of bias variation. A 10,000 ohm potentiometer is connected between the antenna binding post

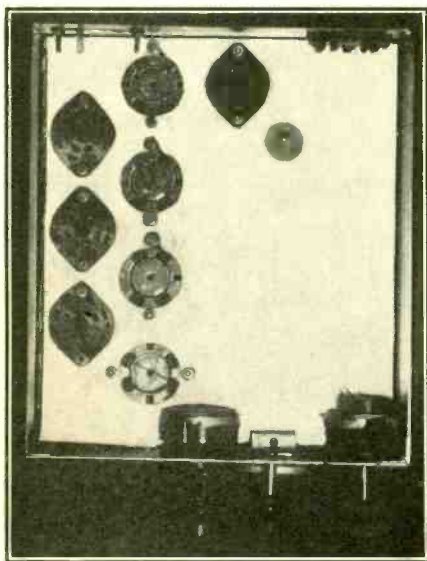

View of the bottom of the t.r.f. tuner before wiring was begun.

and the grid bias resistor common to the three 6K7 tubes. The slider of the potentiometer is connected to the chassis, as is usual in circuits of this type. The common bias resistor has a value of 150 ohms. Since this resistance serves three tubes the limiting bias is slightly more than 3 volts. The slight overbias is in the interest of stability and freedom from noise.

Bias Detection Used

The range of the volume control is sufficient completely to cut out the strongest station even though a long outdoor antenna is connected to the antenna binding post. Incidentally, the sensitivity of the circuit is so great that for local stations it is not necessary to use any antenna at all.

The 6J7 is used as a grid bias detector. The bias is provided by a 50,000-ohm resistor in the cathode lead. This value of bias resistor assumes that the plate coupling resistor in the plate circuit is .5 meg. This resistor is not included in the tuner. The screen voltage on

the detector tube should be comparatively low, and the correct value is obtained by connecting a .5 meg. resistor between the screen and the B supply.

Although the amplification in this circuit is extremely high, there is practically no coupling between the elements of one stage and those of the other stages, because all high potential leads are very short.

While by passing in necessary to eliminate coupling in common leads, not as large or as many by pass condensers are needed as in a radio frequency amplifier using glass tubes. A condensed of only 0.1 mfd. is used across the bias resistance for the three 6K7 tubes. No larger condenser was necessary. There is also a condenser of the same value connected between the cathodes and the screens of the three amplifier tubes.

Capacities Used

In the detector circuit the by pass condensers are somewhat larger because here audio frequencies as well as radio frequencies are involved. There is a .5 mfd. condenser connected between the cathode and ground and another of the same value between the cathode and the screen. Smaller condensers were tried at these points and when they were as low as 0.1 mfd. there was a slightly appreciable suppression of the low audio notes.

In the plate circuit of the 6J7 is a .00025 mfd. condenser. If the high audio frequency response of the completed receiver—that is, tuner and public address amplifier—is too high, the plate by pass condenser may be made larger than .00025 mfd.

The screen by pass condensers and the plate by pass condenser are connected to the cathode. This is the best point theoretically. Practically it makes no difference if these condensers are connected to the chassis instead of to the cathodes.

Ratings of Condensers

The voltage divider required for this tuner consists of one 25,000 ohm bleeder and a 15,000 ohm dropping resistor. This combination of resistors, in this particular circuit, divides the voltage so that out of a total of 250 volts 100 volts is applied to the screen and 150 volts is dropped in the 15,000 ohm resistor. This 15,000 ohm resistor should have a rating of at least two watts. All other resistors in the circuit may be one-watt resistors, even smaller.

The .1 mfd. condenser connected between the chassis and the B plus lead is auxiliary to the large filter condensers in the rectifier. The rating of this condenser should be considerably higher than the highest voltage that will appear across the B supply. If the B supply voltage is 250 volts, which is recommended, the voltage rating of the condenser should be at least 400 volts. The other by pass condensers in the circuit across comparatively low voltages, except the plate-to-cathode, or plate-to-chassis condenser in the output circuit of the 6J7. This condenser should be of the mica dielectric type.

The others may be paper dielectric condensers with a rating of 200 volts or more.

Whether or not to build the power supply into the "front end" depends on the availability of the required voltages. If the public address amplifier is so constructed that it is inconvenient to tap the filament transformer and the plate supply, or if the filament transformer does

as part of the "front end" a rectifier assembly tube is necessary on the chassis. There is plenty room for this tube in the left rear corner of the chassis. The use of a rectifier tube, of course, requires the use of a power transformer and a filter. The chassis has been designed with sufficient depth to accommodate the power transformer, a filter choke, and some filter con-

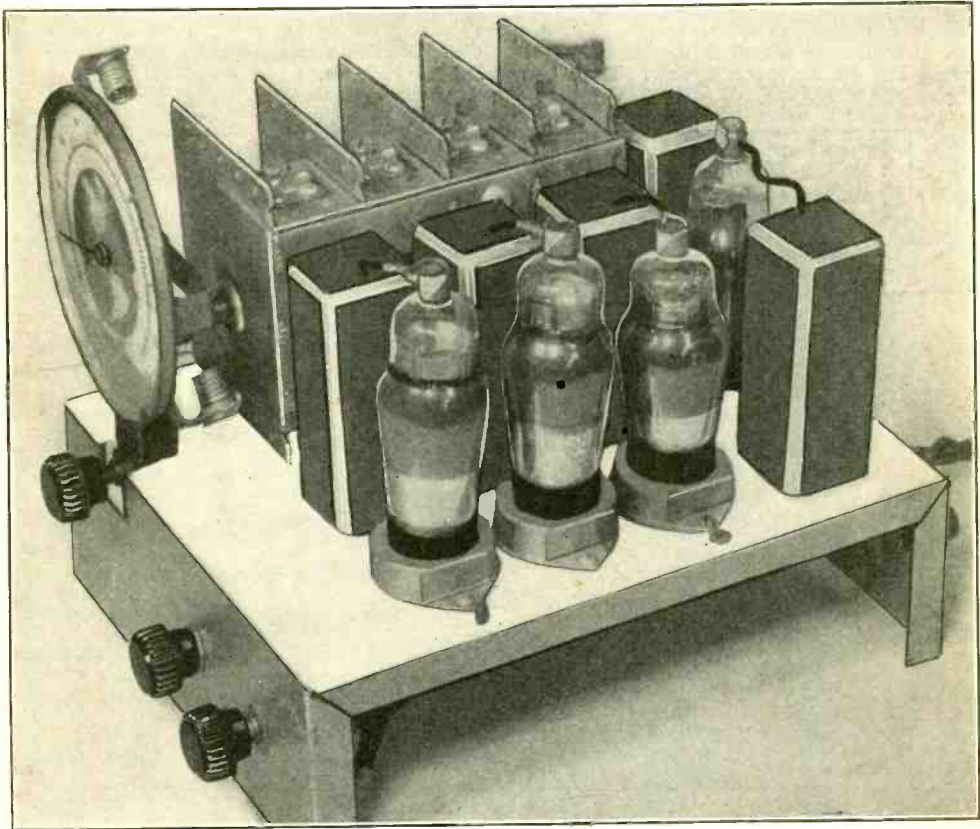

A superheterodyne tuner, with automatic volume control, with tube options stated. The 58, 2A7 and 55 tubes above are for 2.5 volts on heater, other tubes would be for 6.3 volts, in line with the diagram on page 25.

not have the right voltage, it is better to build in the entire power supply with the tuner.

In the t. r. f. circuit illustrated in the photographs only the filament transformer was included with the tuner because the tubes in this required 6.3 volts whereas the tubes in the amplifier required 2.5 volts. In the circuit diagram the 6.3-volt filament transformer is indicated below the main circuit.

It should be noticed that there is a noise filter across each of the windings. It is not always necessary to use two filters of this type, but it is always desirable that one be used across the primary. It is neither desirable nor necessary to use larger condensers that .1 mfd. in these filters.

In case the full power supply is to be built

densers. In choosing a power transformer and rectifier tube for the power supply for a circuit of the type shown in the diagram it should be realized that total current required by the plates, the screens, and the voltage divider is less than 50 milliamperes.

The two photographs of the chassis show clearly the layout of the "front end". The picture at the left shows the rear. The three tubes at the left of the four shielded coils are the 6K7s and the tube at the right of the nearest coil is the 6J7. In this picture the antenna and ground binding posts are shown at the left and the output socket at the right. The photograph at the right shows the front view of the chassis. Of the three knobs the left is

(Continued on next page)

(Continued from preceding page)

the line switch, the middle the tuning control, and the right, the volume control.

Attention is called to the extremely short leads from the coils to the tube caps. The exposed portions of these leads is not much over one inch. The distance between any two adjacent leads is a little more than 2.5 inches. Therefore the coupling between stages is virtually nil as far as the grid leads are concerned.

Under the panel the plate leads are equally short and they are placed at the same distance apart. The leads from the coils to the con-

It will be observed that the chassis is not symmetrical. The condenser shaft is considerably to the left of the middle line of the chassis. There are several reasons for this dissymmetry. First, the chassis had to fit in a particular space. Second, no more material was used in it than necessary. Third, if a narrow audio amplifier be placed on the left of the chassis the total width will be such that the condenser shaft, and hence the dial, will be in the center. The three control knobs were placed so that when the chassis is placed behind a panel in a cabinet, the lack of symmetry will not be noticeable.

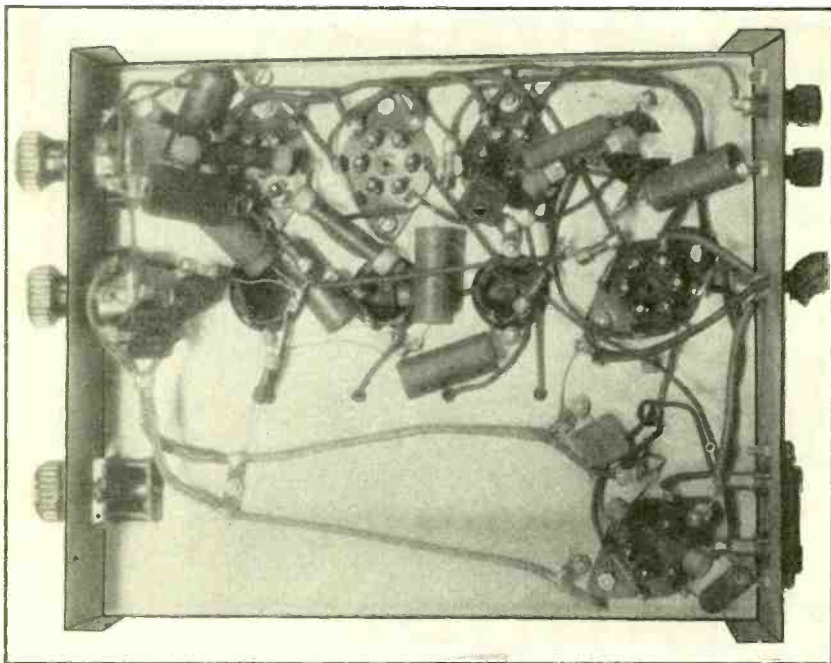

Bottom view of the superheterodyne tuner, the diagram of which is on opposite page.

denser stators are also very short. The stray coupling that exists between stages is therefore minute. Only with metal tubes is such a layout possible.

Chassis Design Explained

The output socket, which is shown on the left photograph, has six contacts. Two of these were intended for leading a 6.3-volt line from the filament transformer to the public address amplifier to permit the use of metal tubes in this also without changing the power transformer in this part. One was intended for leading the output of the 6J7 to the input of the first tube of the public address amplifier and two of the remaining for leading the plate supply from the public address amplifier to the "front end." The output jack and the coupling cable between the tuner and the amplifier can be arranged to fit the requirements in any particular case.

The electric coupling between the 6J7 and the audio amplifier is supposed to be resistance-capacity. As has been pointed out already, the plate coupling resistor should have a value of 0.5 megohm. The grid leak for the first audio tube should have the same value. The coupling condenser between these resistors, or between these resistors, or between the plate of the 6J7 and the grid of the next tube, should have any value from 0.006 mfd. up to about 1mfd. The larger the coupling condenser capacity the better will be the response on the low notes. It is hardly necessary to make the condenser larger than .02 mfd. However, .02 mfd. is recommended and it should preferably be a mica dielectric condenser.

Superheterodyne Tuner

Besides the tuned radio frequency tuner, using metal tubes, there are shown a superhetero-

dyne tuner, using glass tubes, and a combination t.r.f. tuner for broadcasts and converter for short waves, using metal tubes. The super-heterodyne may be built for metal tubes, if desired, the selection of tubes being noted on the diagram. Although a glass tube is even then suggested for the super tuner, a metal one may be used, as it is a new tube, announced after the circuit design was completed. This is the 6Q7 duplex diode high mu triode, which should be resistor and not transformer loaded. The resistor is .1 meg., and to the return of this resistor for all construction of the super tuner the B plus lead should be connected, around 200 to 250 volts.

The super may be built with 465 kc or 175 kc intermediate frequency. Transformers for 456 kc will tune to 465 kc. The i.f. selection is up to the constructor. The lower intermediate frequency gives higher interchannel selectivity, while the higher i.f. gives a better image ratio, because at the high frequency end of the broadcast band, where this may be of some importance, the oscillator frequency represents a greater difference from the carrier frequency. The difference in results is not of vast importance, not sufficient for instance to justify buying 175 kc coils if you have 465 kc coils, but if a selection must be made de novo, it might be

(Continued on next page)

Circuit for the Five Tube Super Tuner

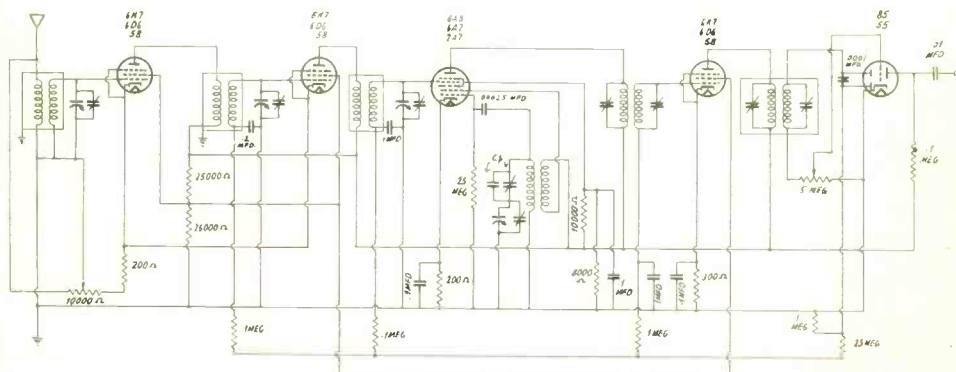

Cp is the padding capacity of this broadcast super tuner. Across a fixed mica condenser an air dielectric trimmer should be connected. The constancy is improved compared to use of compression type mica padders. The common screen lead should be bypassed to ground by .25 to 1 mfd. B plus, 200 to 250 volts, connects to the bottom of the .1 meg. resistor (extreme right) and B minus to ground. This tuner is for a.c. operation.

LIST OF PARTS

Coils

Three shielded radio frequency transformers and one oscillation transformer (all for broadcast band, oscillator coil for 175 kc or 465 kc, as preferred).

Two shielded intermediate frequency transformers, primaries and secondaries tuned (175 kc or 465 kc, as preferred).

Condensers

One four gang tuning condenser, .00035 to .0004 mfd., with built in trimmers.

One .0001 mfd. mica.

One .00025 mfd. mica.

One .0004 mfd. fixed condenser and one air dielectric 75 mmfd. condenser across it, to constitute Cp, for 465 kc i. f.; one .001 mfd. fixed mica condenser and 100 mmfd. air dielectric trimmer across it to constitute Cp for 175 kc.

One .01 mfd.

Six .1 mfd.

Note: No bypass condenser is shown in diagram from common screen lead to ground.

One should be included of high enough capacity to stop any self oscillation present, usually .25 to 1 mfd., 400 v.

Resistors

One 10,000 ohm potentiometer with a.c. switch attached

Two 200 ohms.

Two 25,000 ohms.

Two .25 meg.

Four .1 meg.

One 10,000 ohms.

One 8,000 ohms.

One 300 ohm.

One 1 meg.

One .5 meg. potentiometer (read decimal point into diagram where point fell out).

Other Requirements

One chassis.

Five tubes

One dial.

Three knobs.

Line cord, plug.

Four grid clips.

Five tube shields.

Five six hole sockets.

Antenna, ground, output posts.

(Continued from preceding page)
for 175 kc, since only the broadcast band is considered. For short waves 175 kc would not be suitable, so if one has in mind the possibility of adding short wave switching later, he should select 465 kc.

Coil Winding Instructions

The coils for the carrier level are wound on 1 inch diameter and consist of 130 turns of No.

as the oscillator will oscillate all over the band only when the plate coil is connected the right way, so connect grid coil as others were connected, and try the plate coil with reversed connection if oscillation is incomplete. Even if the coil is connected the wrong way there may be oscillation over the higher frequencies of the band due to capacity coupling. For 175 kc the secondary consists of 100 turns of No. 32 enamel wire (180 microhenries), tickler wound over

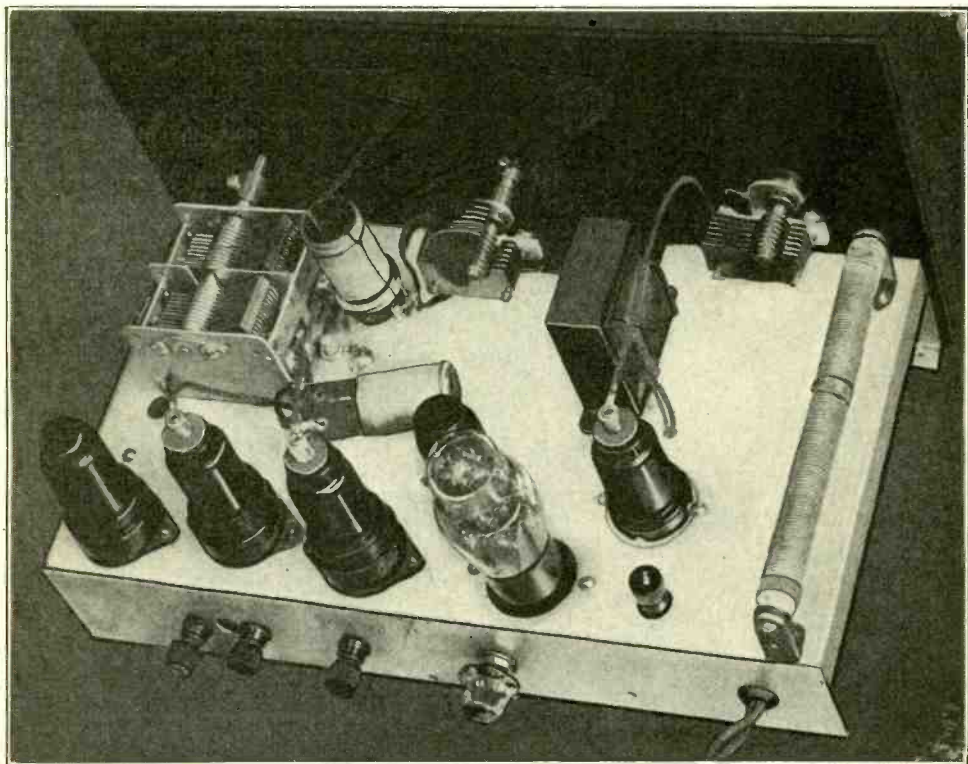

A combination tuner was made up of spare parts as shown. The broadcast band was covered, also the foreign short wave band, by switching to converter use. The glass tube is the 12Z3 rectifier. The others are metal tubes.

32 enamel wire, tight wound. A space of about 1/16 inch is left, and then the primary is wound, consisting of 30 turns of any fine wire. The three primaries are alike. But if one desires stronger response on low frequency stations, at some selectivity sacrifice, 600 kc to 530 kc, for instance for local reasons, then the antenna primary may consist of 50 turns of No. 30 enamel wire wound "ragged" at just below the end of the secondary. The polarities of connections are not important, but make them all alike for these three tube circuits.

The oscillator coil for 465 kc consists of 68 turns of No. 28 enamel wire, which will take up practically the entire tubing length. The tickler, consisting of 22 turns, any fine wire, is wound over the secondary, two layers of wrapping paper or one layer of Empire cloth separating them. The polarity of connection is important,

the secondary, 32 turns of any fine wire, same insulating separation as before. The position of both oscillator ticklers may be near the end of the grid coil that goes to ground, usually the end nearer the chassis. The secondary inductance was selected so that if the .001 mfd. is accurate the 100 mmfd. trimmer would be set about half way.

The super is intended for a.c. operation.

Combination Tuner

The combination tuner using metal tubes was made up, using parts on hand. Only a few broadcasting stations were desired to be received, these were in the lower frequencies, 860 to 570 kc, hence bank wound secondaries with large honeycomb primaries were used, for high gain. If selectivity is of consequence the two turn connection to secondaries for capacity

coupling should be removed, or the honeycombs removed and primaries put on as described for the foregoing ticklers. Or coils may be wound as for the r.f. level of the super, and these coil directions also apply to the t.r.f. tuner first described.

Increased Efficiency

When only short waves are to be received it is preferable to tune the primary winding of the first intermediate coil, that is, the coil that follows the 6L7. Tuning this winding increases the conversion efficiency of the tube

used in the first coupler could be substituted. One advantage of having a variable intermediate frequency is that interference can often be avoided by changing the frequency.

The intermediate frequency selected may be such that the oscillator frequency is more than midway between two strong stations when the set is tuned to one of them, although 590 kc was used in the constructed model. Both will then come in with almost equal strength, except for such discrimination as is introduced by the r.f. tuner. A slight change in the intermediate frequency, and therefore in the oscillator fre-

Combination T.R.F. Tuner and Converter

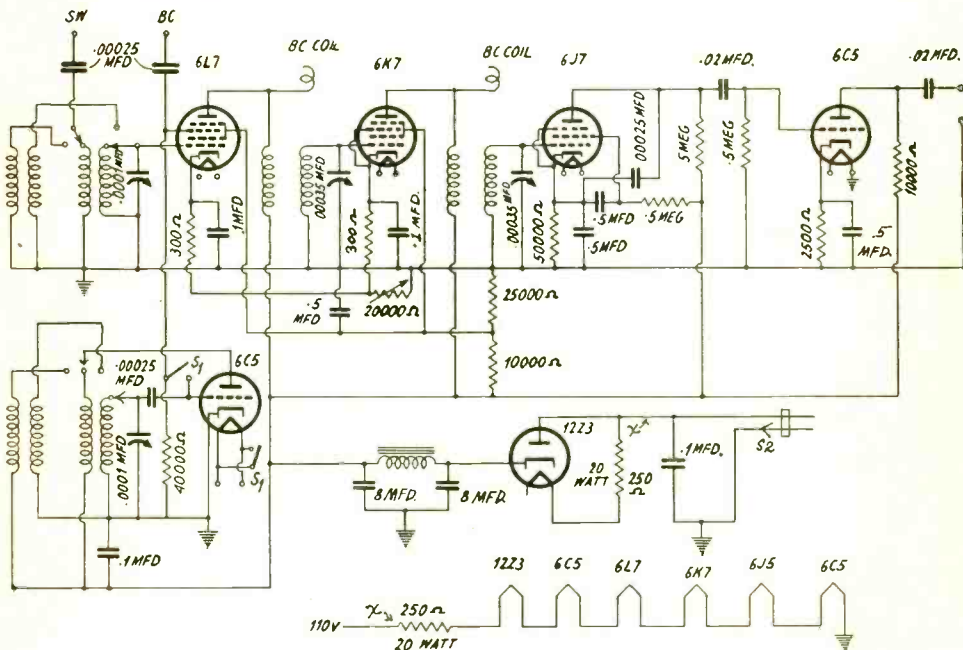

The circuit diagram of the combination tuner is on top, the detail of the series heater connections for universal operation is below. Spare parts were used for gaining fair results on the broadcast band and good results on short waves, with t.r.f. level set at 590 kc.

and at the same time it increases the selectivity. The gain in the conversion efficiency about offsets the loss of gain incurred in changing from a high-gain coil to a loose-coupling coil. Of course, tuning the primary of the first coil requires a change of coil.

It would be best to use a coil with extremely loose coupling between the two windings, which should be equal, so that both secondary and primary could be tuned. If there is only one tuning condenser available, the coupling should be close and the untuned winding should be in the grid circuit.

Other Intermediate Frequencies

The coupling between the 6K7 and the 6J7 may remain as it is or a coil similar to that

quency, will change the relative intensity of the two stations so that the signal from one entirely disappears. Another advantage of the variable intermediate frequency is that the tuning condenser by which the I.F. is varied can be used as a vernier tuner for the signal.

In the combination tuner the separate oscillator is switched on by opening the heater short, and the antenna is moved to the short wave position (SW). The oscillator and the modulator are tuned by separate .0001 mfd. condensers, and the foreign broadcast band is covered. The frequency range is from 20 mcg. to about 9 mcg. Any one interested in building this set may obtain a list of parts and coil winding data by addressing Information Editor, RADIO WORLD, 145 West 45th Street, New York City.

Value of Capacity Tests

Radio Frequency Problems Simplified

By Capt. Peter V. O'Rourke

IN last month's issue were published data on measurement of small capacities, using a much larger capacity calibrated condenser. The method is based on the enlargement of the apparent capacity ratio when the unknown is across the standard. For instance, the frequency ratio in a generator is 2, using fundamental and second harmonic, actual capacity values unknown, but actual capacity ratio is 4 since it is the square of the frequency ratio. The standard condenser does not show a ratio of 4 but a larger ratio, because the circuit capacity is included.

So, the condenser alone would show a capacity ratio of 4, instead we read apparent values from the standard of 280 and 40 mmfd., a ratio of 7. As values these are imaginary. But they give the clue to the reality, because the enlargement of the real ratio to the imaginary one is a measure of the unknown, Cx.

A Case Worked Out

We can find Cx by the formula printed last

HARMONIC ORDERS DETERMINED FROM FREQUENCY RATIOS

If a generator is frequency calibrated, and higher frequencies are to be measured by harmonics, besides methods of disclosing the unknown published last month, the fundamental frequency ratios may be used. The harmonic orders yield the following ratios:

Harmonic Orders	Frequency Ratio
1st and 2d.....	2
2d and 3d.....	1.5
3d and 4th.....	1.333
4th and 5th.....	1.25
5th and 6th.....	1.2
6th and 7th.....	1.167
7th and 8th.....	1.143
8th and 9th.....	1.125
9th and 10th.....	1.111
10th and 11th.....	1.1
11th and 12th.....	1.091

The above ratios of frequencies are the square roots of the capacity ratios. For capacity measurement see tables on next page, because if the capacity at one response setting is known the capacities at other settings yielding responses are according to the tabulated capacity ratios.

month, 333 ($C_{max} - 4 C_{min}$). C_{max} is 280 and C_{min} is 40, from the stated readings given. Then $280 - 160$, or 120, is divided by 3, and there is your answer, 40 mmfd. It is accidental that 40 appears twice.

Only the fundamental and second harmonic may be used, for application of .333 ($C_{max} - 4 C_{min}$).

As other harmonic orders are used, the multipliers to be applied to the difference increase, those for the minimum decrease.

The multiplier can be omitted by recasting the formula.

$$C_x = \frac{C_{max} - 4 C_{min}}{3} \text{ (original)}$$

$$C_x = \frac{C_{max}}{3} - \frac{4 C_{min}}{3}$$

$$C_x = \frac{C_{max}}{3} - \frac{3 C_{min}}{3} - \frac{C_{min}}{3}$$

$$C_x = \frac{C_{max}}{3} - \frac{C_{min}}{3} - C_{min}$$

$$C_x = \frac{C_{max} - C_{min}}{3} - C_{min}$$

$$C_x = \frac{D}{3} - C_{min} \text{ (using D to denote difference)}$$

The above holds for the first and second harmonics.

Elimination of the multiplier renders the system more rapid of application by mental arithmetic for the first and second and the fourth and fifth harmonics particularly.

Higher Harmonic Orders

The three succeeding harmonic steps are covered by the following:

Harmonic Orders	Cx Equals
2d and 3d.....	8 D - C_{min}
3d and 4th.....	1.2865 D - C_{min}
4th and 5th.....	1.778 D - C_{min}
5th and 6th.....	2.271 D - C_{min}

By using higher orders, as fourth and fifth, smaller capacity differences on the standard are used, hence a 50 mmfd. condenser would suf-

five. Here are four examples and answers based on the immediately preceding data:

Harmonics	C_{max}	C_{min}	C_x
1st and 2d	280	40	40
2d and 3d	200	75	-25
3d and 4th	170	92.3	7.7
4th and 5th	146	96	4

Negative Sign Explained

In the case of the negative sign, this merely discloses that the difference is less than the minimum, otherwise the sign has no significance.

The application of the method to the fourth and fifth harmonics may be well undertaken by having a frequency calibrated receiver cover the broadcast band, and a capacity calibrated generator cover 100 to 150 kc. Divide the lower read frequency (generator) into the higher (receiver) frequency to determine one harmonic order, then the next response at smaller generator capacity is the next lower harmonic order, and in the opposite direction (greater generator capacity) is the harmonic order one lower than the original.

Capacity Ratios Compared

The harmonic orders may be derived from the following capacity ratios:

Harmonic Orders	Capacity Ratio
1st and 2d	4
2d and 3d	2.25
3d and 4th	1.77
4th and 5th	1.5
5th and 6th	1.44
6th and 7th	1.361
7th and 8th	1.31
8th and 9th	1.265
9th and 10th	1.234
10th and 11th	1.21
11th and 12th	1.19

If a calibrated condenser is used in a generator or other parallel tuned circuit the circuit capacity should be measured and added to the condenser calibration. The measurement is made by the method discussed in this article.

A signal generator of the type shown on page

This device, if frequency calibrated, may be used as a signal generator, hum modulated on a.c., no modulation on d.c. If C_c is calibrated in capacity also, then very small capacities put across C_c may be measured, formulas and tabulations being contained in the text. Also somewhat larger capacities are measurable at C_x and much larger ones if the unknown replaces C_f .

HOW CAPACITY METER WORKS

THE diagram at bottom of the page illustrates a method of measuring capacities used at r.f. and i.f. levels. If a calibrated condenser is on hand—curves for two National Company condensers were printed in the December issue—it is connected at C_x and frequency responses at C_c noted because the neon light will go out, on fundamentals. C_f is equal to C_c maximum. If C_x is the standard at maximum, higher unknowns may be measured by replacing them for C_f .

28 of the December issue was measured, and the circuit capacity (coil, tube, wiring) was only 9.2 mmfd. This did not include the generator condenser minimum.

The calibrated condenser used was a General Radio 247 which had been specially calibrated by Edward M. Shiepe, using his precision equipment. The curve was very accurate. The 247 replaced the condenser in the generator, for making the measurement.

The capacity measurements by this method are not idle or merely informative experimentation. Tracking trouble is frequent in superheterodynes. Measurement of the oscillator circuit minimum capacity, substituting the standard condenser and shorting padder, may disclose a very high minimum. Usually insertion of grid leak and grid condenser cures this trouble. Check back when the remedy is applied.

Coils sometimes give tracking trouble—too much distributed capacity or particularly too much capacity between primary and secondary. Take two adjoining terminals of coils and treat these as if connections to an unknown condenser and connects to the standard, other coil terminals free. Measure the capacity between windings that way.

There are numerous other practical uses.

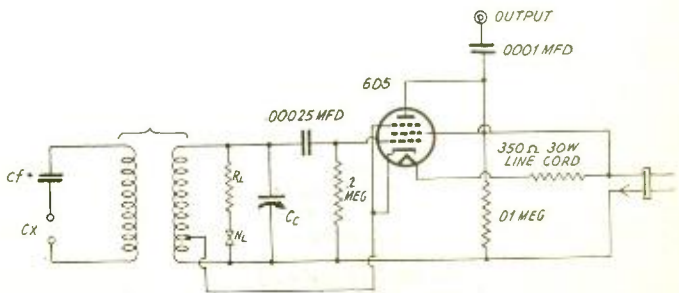

Generator as a Monitor

Metal Tube All Wave Universal Model

By Albert E. Voorhis

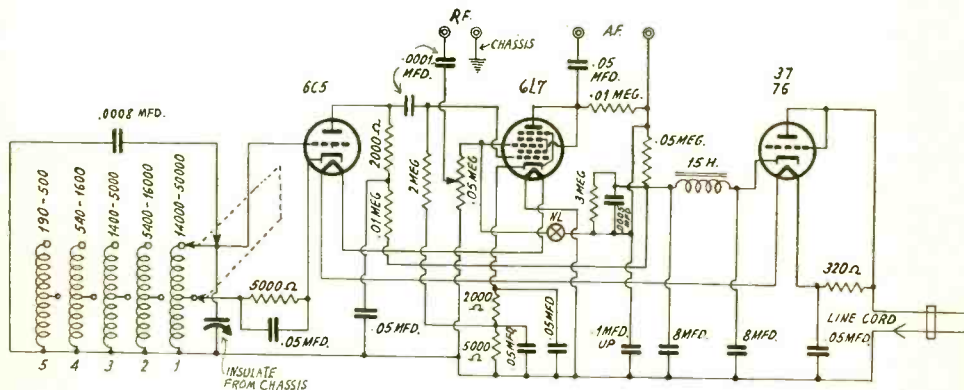

A universal allwave signal generator, using the 6L7 tube as modulating amplifier. The output is taken from Grid No. 3, which is biased more negatively than is the control grid. The 6C5 is the oscillator. The rectifier is a glass tube, the others metal. Read Band No. 1 as 140-500 kc.

THE 6L7 lends itself to some interesting uses in signal generator practice. It is well known that as soon as a new tube is announced for a particular use somebody comes along with some different use. This is such an example. The 6L7 is particularly intended for mixing purposes, one of its grids, No. 3, being a high mu type, for injection of the oscillation voltage. Here we turn things completely about and use Grid No. 3 for output coupling instead of input coupling. And to maintain that grid negative in respect to the control grid we tap the biasing resistor, returning control grid to the tap and Grid No. 3 to B minus.

The reason is that we use the 6L7 not as a mixer primary but as an amplifier, and Grid No. 3 permits electron coupling of the output in a manner that frees the generator from all effects otherwise produced by the load circuit, the one to be measured or peaked. For instance, the frequency of generation is the same, no matter what the load attached to the r.f. output.

One Mixer Purpose Served

There is some mixing, however, as the audio frequency produced by an oscillating neon tube is injected into Grid No. 3, or not, as you please, as this modulation is included or excluded by front panel switching.

The 6L7 pentode is modified to the extent of tying the screen and plate together, whereupon the tube becomes a quadrole. This is advan-

tageous to the present purposes, which include audio frequency output, which earphones will now more sensibly load. The audio may be the modulating frequency alone taken out, for delivery to an audio amplifier for gain measurements by independent instruments, or may consist of inserting 'phones for listening to beats with unknown frequencies put into the radio frequency posts.

Normally a signal generator is a frequency meter, that is, a device to measure frequencies of a receiver or of a channel or level in a receiver. The audio use which consists of putting earphones at the a.f. posts adds the advantage of a monitor, or listening post. Therefore a transmitter frequency may be measured by listening at the posts of the present device, instead of requiring listening at the transmitter, a facility with which the transmitter may not be equipped.

So we have both a frequency meter and a monitor.

Little Taken Out of 6C5

The circuit consists of two metal tubes, one the 6C5 oscillator, since it is the best oscillator of the group, and the other of the 6L7 amplifier-modulator.

Very little oscillation voltage is taken out of the 6C5, in fact, the d.c. load for bias, 5,000 ohms, is $2\frac{1}{2}$ times the a.c. load for output. However, we want but little, since we have an amplifier tube that, besides acting as buffer to augment the freedom of the measured circuit

LIST OF PARTS

Coils

Five tapped coils for covering 140 kc to 50 mc
One midget type B choke, as used in universal receivers

Condensers

One 402 mmfd. tuning condenser, closes to the right
Six .05 mfd. tubular
Two .0001 mfd. mica
One .0005 mfd. mica
One .1 mfd. or higher
One dual 8 mfd. electrolytic block
One .0008 mfd. precision fixed mica

Resistors

Two 5,000 ohms
Two 10,000 ohms
One 2 meg.
Two 2,000 ohms
One 50,000 ohms
One 3 meg.

One 320 ohms, built into the line cord
One 50,000 ohm potentiometer with switch

Other Requirements

One chassis and front
Two octal sockets
One cover
One five hole socket
Four binding posts, or two leads and two r.f. output posts
One frequency calibrated dial
One knob and three bar handles
One small grid clip
One 6C5, one 6L7 and one 37 or 76 tube.
One line cord and plug
One two deck, five position switch.
One on-off switch for the .0008 mfd. fixed condenser
One neon lamp without limiting resistor built in
Two escutcheons for dial
Two plates for attenuator and coil switch

from effect on the oscillator, boosts the oscillation amplitude.

The rectifier is a glass tube, either 37 or 76.

The circuit operates on 90-130 volts a.c. or d.c., being therefore universal, and covers the following frequencies at the numerical switch point positions indicated on the diagram:

- (1)—14,000 to 50,000 kc.
- (2)—54,000 to 16,000 kc.

- (3)—1,400 to 5,000 kc.
- (4)—540 to 1,600 kc.
- (5)—140 to 500 kc.

Locations on Scale

Besides the foregoing, if it is desired to switch in a fixed mica condenser of .0008 mfd., the frequencies for Band No. 5 become 83 to

(Continued on next page)

The three tubes are symmetrically disposed about the chassis top. The oscillator is the 6C5 triode, while the amplifier is the 6L7, also put to other uses. Both of these are metal tubes. The rectifier may be a 37 or a 76, or if one desires to adhere to the metal tube selection, a larger new rectifier, the 25Z6, may be included, requiring a lower resistance line cord, 240 to 250 ohms. The circuit is built on the chassis, which is spot welded to the front panel. The cutout in the shield cover is for access to the r.f. output posts. If the coils are not far from the chassis there is no detuning when the cover is put on.

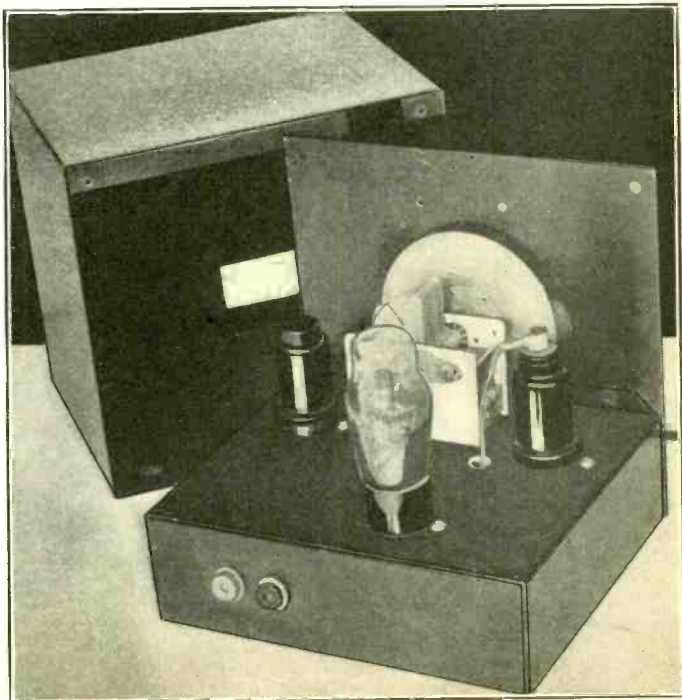

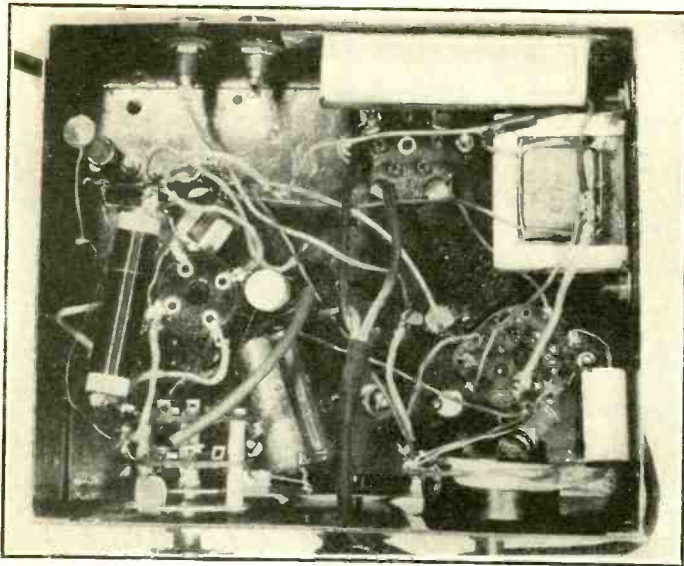

The low frequency coil is the honeycomb just behind the coil switch in the metal tube signal generator. The inductance is 3 millihenries. The broadcast band coil may be wound by the experimenter and has 230 microhenries inductance. The other coils successively have inductances of 33, 2.55 and .33 microhenries. At right is the B choke and above it the dual 8 mfd. filter condenser.

(Continued from preceding page)

100 kc, and by switching in the same condenser for Band No. 3 the frequencies become 830 to 1,000 kc.

The frequencies for the five bands listed above appear on a silvered disc direct drive dial, using two tiers on one side, viewed at the same escutcheon, at right as one observes the panel from the front. The outside tier is 140 to 500 kc, read directly for the fifth band. The inside tier is 540 to 1,600 kc, also read directly, for the fourth band. The third band is the fifth multiplied by ten, the second is the fourth multiplied by ten, and the first is the fifth multiplied by 100.

When the switch introduces the .0008 mfd. condenser readings are taken from left band escutcheon and there is direct reading in frequencies on inner tier, 83 to 100 kc, also in wavelengths 3,010 to 3,600 meters, outer tier. For using the fixed condenser on the third band, the frequencies are the foregoing multiplied by ten, that is, 830 to 1,000 kc, and the wavelengths as read are divided by 10, e.g., 300 to 360 meters.

Reason for Low Frequencies

The lowest frequencies, 83 to 100 kc, permit testing old-style superheterodynes that has i.f. around 90 to 92 kc. For close readings from 830 to 1,000 kc, 300 to 360 meters, the fixed condenser switch may be closed for Band No. 3.

There is no missout of frequencies generated, although there is a slight missout on the dial, that is, nothing calibrated between 500 and 540 kc. This arises on two bands, since the same scale is used twice, but any frequency between 500 and 540 kc may be generated by turning to an uncalibrated response point beyond 500 kc, and then turning the dial back on the same band, using more tuning condenser capacity, the unknown being twice

the frequency now read. That is, the second harmonic is used.

As against this there is overlap between succeeding bands, e.g., the broadcast band terminates at 1,600 kc, but the next band starts at 1,400 kc, so that frequencies difficult to determine accurately on many generators, say, the high frequency end of the broadcast band, become very easy to determine with the present method, and this applies to the low frequency end of the 14,000 to 50,000 kc band.

The coverage therefore is from 2,142 meters to 6 meters.

How to Adjust the Dial

The circuit is built according to the diagram. The broadcast and higher frequency coils may be wound as directed, but the intermediate frequency coil is a honeycomb and can not be wound without a special machine. It has an inductance of 3.1 microhenries and is tapped at one-eighth the total number of turns.

The dial adjustment is made on the basis of the broadcast band, because of the ready access to frequencies. The dial is on the tuning condenser shaft, between condenser frame and rear of panel, just far enough back from the rear of escutcheons to prevent touching. A broadcasting station is tuned in on a receiver, 1,400, 1,450, 1,500 or 1,600 kc. The dial is not securely fastened by the setscrew, just held firmly enough to the shaft to turn with the shaft. Then the condenser is held in position to retain the generation, beating at lowest recognizable frequency, and then the dial is set to read just that frequency. This would be 1,400, 1,450, 1,500 or 1,600 kc. Then the condenser knob is turned until another response is gained, now due to the second harmonic, and the reading on the dial noted. This is merely to check up on the inductance. Suppose the frequency of the first setting is 1,450 kc. The

next reading should be half that, or 725 kc. This is half way between the bars representing 720 and 730 kc. The coincidence should be perfect. The accuracy here is better than 1/2 of one per cent. This applies to the frequencies between the two settings.

Adjustment of Inductance

If the dial reads too low in frequency, that is, instead of the required 725 kc in this example, the reading is 700 kc, the inductance is too low, and turns should be added to the grid end, one turn at a time. If the dial reads too high the inductance is too high, and turns removal are in order.

Battery version to cover the same frequencies generated by four bands of the universal model. The 14,000 to 54,000 kc band could not be supported throughout with oscillation and therefore was omitted.

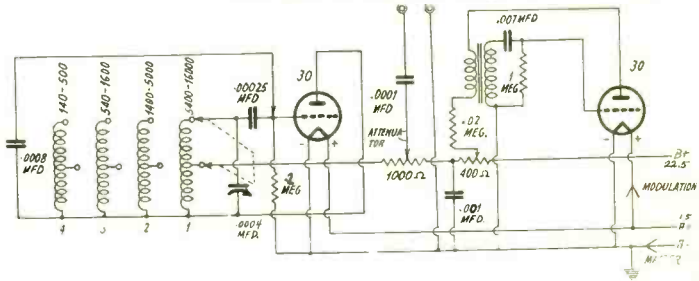

When the 2-to-1 ratio is established this way the inductance is correct. The high frequency end should be checked again.

Now some station near the low frequency end is tried. This may be 540 to 600 kc. The reading may or may not be exactly right now. The 1 per cent. accuracy permits a variation of about .5 kc in this region, and if such divergence exists it can not be controlled. Usually the divergence does not exceed .5 per cent.

With the dial properly set, the condenser never being molested, and no trimmers used, the only selections for higher frequencies refer to inductance. The intermediate short wave band, 1,400 to 5,000 kc, is established by the proper inductance, the test being made at the low frequency end, so a broadcasting station is used, and it will naturally be the same station as served a similar purpose for the broadcast band. If the dial for the 1,450 kc station (or any other station near this frequency) reads too high in frequency there is too much inductance, if the dial reads too low in frequency there is too little inductance. Add turns to increase inductance, remove turns to decrease inductance. The other end of the tuning takes care of itself.

Special Harmonic Test

It is possible even with a broadcast band receiver to check up the second and sometimes even the third harmonics of the station frequency. Take again 1,450 kc. If earphones are used in the receiver, and generator closely coupled to the set, when generator is at 2,900 kc a faint beat will be heard in the receiver, and other when generator is at 4,350 kc. These frequencies are 1,450 x 2 and 1,450 x 3. The presence of beats is due to mixing of the generation frequency with the harmonic frequencies in the set's detector. As stated, these

are faint. If the set has grid leak detection there will be identifiable response.

T.R.F. Set Preferred

The set should be preferably of the tuned radio frequency type, as superheterodynes may yield two responses for a given generator frequency, due to the image, although the image may be ignored, since the true frequency will be close to what is read from the dial, and the response that coincides with the expected reading is counted, offshot responses ignored.

Oscillation prevails on all bands, except that it may become very small or disappear over part of the first band, 14,000 to 54,000 kc.

This would necessitate a resistor of much lower than .01 meg. in the plate leg of the 6C5, or higher than .05 mfd. bypass condenser, or both smaller resistor and higher capacity. In a pinch the condenser and resistor may be omitted, but their presence is to reduce the hum and help stabilize the oscillation.

In a battery version of the same coil-condenser system the oscillation could not be supported in this high frequency band, so only four switch positions were used. The circuit is quite different from the universal one, but the frequencies covered by the four bands are identical: (4)—140 to 500 kc. (3)—540 to 1,600 kc. (2)—1,400 to 5,000 kc and (1)—5,400 to 16,000 kc.

Stuyvesant Electric Celebrates Its Fifteenth Business Year

STUYVESANT ELECTRIC COMPANY, 140 Washington Street, New York City, has completed its fifteenth year as a distributor of radio parts and accessories.

Headed by Armand Kerekes, graduate electrical engineer, it carries a complete assortment of radio parts.

Some of the lines distributed by Stuyvesant are: Eveready batteries, Rola, Jensen, Utah and Wright De Coster speakers; Universal, Amperite and Shure microphones; Thordarson and GTC transformers; Ohmite and Speer resistors; Centralab and Carter volume controls; Sprague, Curtis, Flechtheim and Duco condensers; Astatic, Upco and Webster pick-ups; Green Flyer and Webster motors; Triplet, Readrite, Weston, Hickok and Clough-Brengle meters; Hytron tubes; Radiart and Electronic vibrators, and a complete assortment of aerial equipment.

Three Band Sim

All Superfluous Parts Omitted—Co

By Edwi

HEREWITH is a three band superheterodyne designed primarily for manufacturing purposes, although it is one that a constructor with even only a small knowledge of radio can build. There are no superfluous parts. There is only one i.f. amplifier (two i.f. coils), as that setup suffices for good reception, and two i.f. stages introduce problems not desired in a simple production circuit.

The 6A7 is used as the converter tube or mixer. Into the control grid, No. 4, is put the frequency at the carrier level. The oscillation voltage is developed in Grids Nos. 1 and 2, and these circuits should be padded for 465 kc. The coil inductances are so arranged that fixed padding capacities may be used with fair accuracy.

Trimmer Locations

Across the oscillator highest frequency secondary is put a small trimmer, so that at the high frequency end of this band there will be more minimum capacity in this one circuit than in the other oscillator circuits, which do not have such a trimmer, since then it is present at the carrier level. The reason is that the highest frequency band is hardest to adjust closely, therefore the oscillator trimmer is needed. The method is borrowed from commercial practice.

The broadcast coils actually used were honeycombs, as shown, and these are commercially obtainable. Without shielding these are about as good as solenoids or similar coils if shielded. Also, space was at a premium.

How to Wind Coils

Any desiring to wind their own broadcast coils would have to go to larger diameter than the honeycombs have, therefore could use secondary of 120 turns of No. 32 enamel wire on one inch diameter, primary wound over secondary, 25 turns of the same size wire. For the oscillator coil, 78 turns of No. 30 enamel wire on the same diameter, would be right,

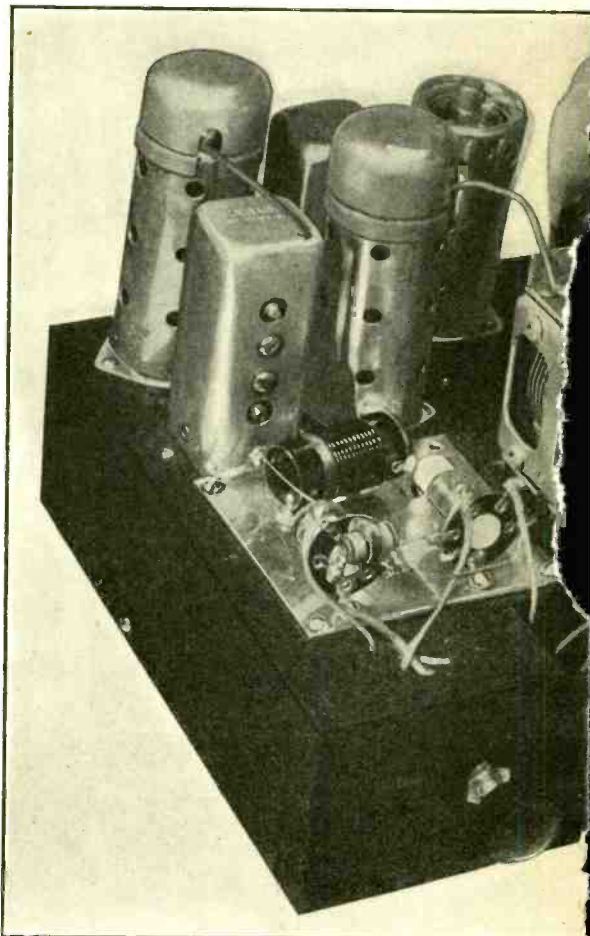

The three band superheterodyne that covers or may be tuned to somewhat higher frequencies. The airplane dial is a commercial product, tracked for these frequencies. As shown, c
The other se

with a tickler of 20 turns of No. 32 enamel wire.

An insulating fabric may be put

between primary reduce the capacity, and aid

Simplified A.C. Set

Coil Winding and Padding Directions

by K. Butler



frequencies from 530 to 20,000 kilocycles, frequencies if less trimmer capacity is used. frequency calibrated, and may be sensibly one set of tuning coils is above the chassis. set is below.

and secondary to coupling partic- the insulation be-

tween the extreme d.c. voltages. The band is No. 1.

The intermediate short wave coil,

Band No. 2, may consist of 30 turns of No. 24 enamel secondary, antenna primary 20 turns of No. 24 enamel wire, wound next to, not over, secondary. The oscillator coil for this band consists of 28.5 turns of No. 28 enamel, tickler 14 turns of the same kind of wire, wound close to the end of the secondary.

Smallest Coils

The smallest coils consist for the r.f. level of 9.5 turns of No. 24 enamel wire secondary, primary 28 turns No. 30 enamel wound next to the secondary. The oscillator coil has 8.5 turns No. 24 enamel, with 5 turns tickler interwound with the secondary.

As stated, the coils actually used were commercial models, and while the data do not duplicate the physical form of the coils used, they do cover the same inductance requirements, and as the winding diameter is larger for the short wave coils, there is a factor some constructors like. The coil then has somewhat lower radio frequency resistance but larger distributed capacity, since this capacity is principally related to the winding diameter, and has nothing particularly to do with the number of turns. The larger capacity is not of a serious nature, only a few micro-microfarads.

All Coils Tight Wound

Tight winding on one inch diameter is considered throughout.

The front view of the receiver is shown, an airplane dial with frequency calibrations on it being used. This dial is intended for the particular make of condenser used, and may be tracked fairly well by the following method.

The coils for any band are constructed as outlined, then if there is any deviation, note the frequency response near the lowest frequency of tuning, and if the frequency reads too low the inductance is too low, so add turns to secondary (primary or tickler need not be molested). If

(Continued on next page)

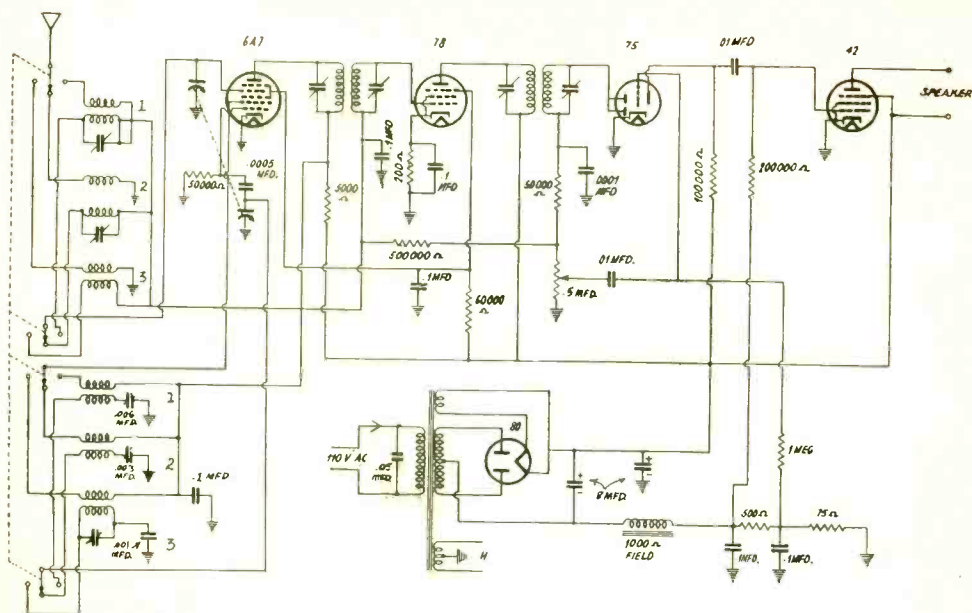

The bands are No. 1, standard broadcast; No. 2, intermediate short wave; No. 3, foreign short wave. The circuit has been reduced to its essentials, but automatic volume control is included in the modulator and i.f. stages

(Continued from preceding page)
the dial reads too high in frequency the inductance is too high, so remove secondary turns. The word "turns" need not be taken literally, as for short waves a fraction of a

turn will make a palpable difference in frequency.

Then turning to the high frequency end, adjust the oscillator trimmer for coincidence with dial.

(Continued on next page)

LIST OF PARTS

Coils

Three sets of two coils each; three coils for modulator, three for oscillator. See text for winding directions
One speaker with 1,000 ohm field, and output for 42 single pentode
Two 465 kc intermediate frequency transformers, primaries and secondaries tuned
One power transformer for five tube set, 115 volt primary, 350-0-350 volt secondary, 6.3 volt c.t. secondary and 5 volt secondary

Condensers

Three 20 mmfd. compression trimmer condensers
One .001 mfd. mica
One .006 mfd. mica
One .003 mfd. mica
One .0005 mfd. mica
One two gang .00035 mfd. tuning condenser, trimmers wide open
One .0001 mfd. mica
Two .01 mfd. tubular

Two 8 mfd. 500 volt electrolytics in aluminum containers
Six .1 mfd. tubular

Resistors

Two 50,000 ohm
One 200 ohm
One 75 ohm
One 5,000 ohm
One 500 ohm
One .5 meg.
One .5 meg. potentiometer with switch
One .1 meg.
One 1 meg.
One .2 meg.
One 60,000 ohm

Other Requirements

One chassis
Three tube shields
Three knobs
Three grid clips
One dial, escutcheon
One D.P., 3 throw coil switch
One medium seven, three six, and two four hole sockets. (Extra four hole is for speaker plug)

The oscillator is concerned with the foregoing tracking directions. The r.f. coils may be checked by putting a small external trimmer across each one as a particular band is tested, to ascertain if adding capacity at the low frequency end of the dial improves response, and if so, add inductance to reach the same output

with the test trimmer off. A very large variable in series with the r.f. tuning condenser will show whether the inductance is too high, for then at some setting of a .001 mfd. condenser the strength would go up considerably, so with this test condenser off, add turns until previous strength is restored.

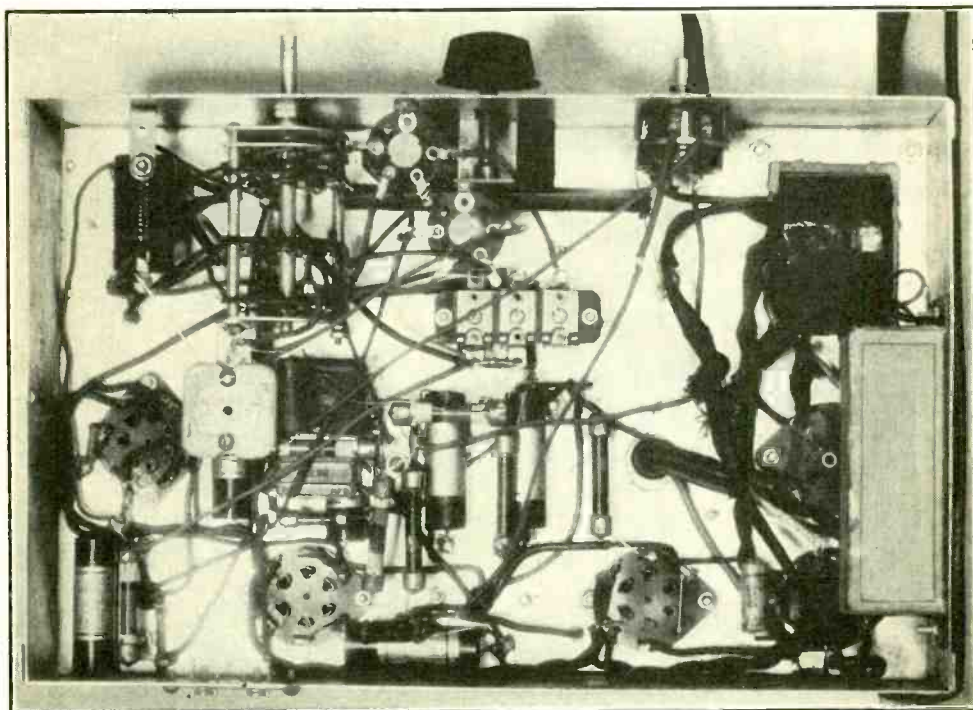

Neatness of arrangement of parts and of wiring make the three band receiver good to look at from the bottom. The wiring was done by Edwin K. Butler.

Bias Compensation in Balanced Amplifier

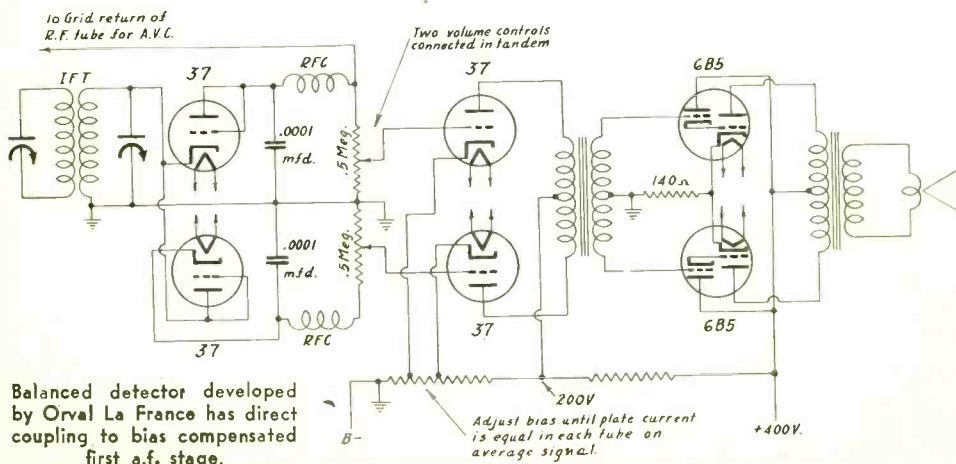

Audio Frequency Oscillators

Unitary and Beat Methods for Sound Waves

By Herman Bernard

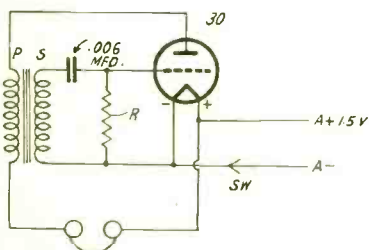

An audio transformer, coupled in proper phase, will enable a small tube like the 30 to oscillate at an audio frequency, with no separate B battery used. Actually there is a B voltage equal to the filament voltage. Positive filament and plate are nearly equipotential.

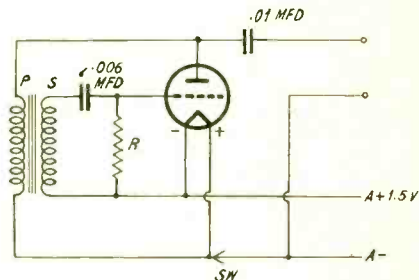

In the example at left earphones were inserted in series with the plate feed, and therefore the sole object was to hear the note directly from the rig. If, however, it is desired to communicate the sound to an external system, the coupling may be as shown.

THE production of audio frequencies with a vacuum tube as generator is a very simple matter, all that are necessary being the tube, socket, audio transformer, grid condenser, grid leak, a 1.5 volt dry cell. To hear the note insert the earphones in series with the B lead as shown.

It looks offhand as if there were oscillation without plate voltage, but this is not true. The negative filament is the point from which reference is made. The primary or tickler winding is returned to positive filament, therefore the plate voltage is equal to the drop across the filament, hence the cell voltage, 1.5 volts.

Some readers may be surprised that there could be oscillation at such low plate voltage, but it is entirely practical, and the reason is that the efficiency is very high at audio frequencies. Incidentally, it is also possible to generate radio frequencies in a different circuit, without any plate voltage, a freak condition practical only after the tube has been set into oscillation, with plate voltage of usual magnitude, and then the plate voltage removed. This was found out some dozen years ago, using a 201A tube.

Small Transformer Satisfactory

All that you can do with the first circuit as shown is listen to the note. The frequency will depend on the characteristics of the transformer and on the values of the grid leak and grid condenser. The better grade transformers usually produce around 2,000 cycles with the constants as stated, but there is no need for a high-class transformer. Any small one will do, provided the ratio is not too high, as then the tickler turns may be too few to produce enough feedback to enable generation, that is, oscillation.

Ratios of around 1 to 3, primary to secondary, have been found satisfactory. Some few transformers, possibly of wretched design, did not produce oscillation, probably because the transformer losses were enormous.

The 1.5 volts for the filament are sufficient, although the usually recommended voltage is 2 volts. If a 3-volt source is to be used, insert a 15-ohm resistor between the set side of the A minus lead, and negative filament of the tube. The difference voltage becomes additive as bias.

Listening to Oneself

It should be noted that in general the tube takes care of its own bias, because the grid end of the grid leak is maintained at a constant average negative value, due to grid current flow.

The plate leg is not suitable for keying, due to the lag. A key could be inserted in series with the grid return, and there should then preferably be an r. f. choke ahead of the key. Then the circuit at grid would begin with the resistor, R, pick up the choke, the choke pick up the key, the other side of the key connected to A minus. Then one could listen on the phones to his own keying.

The listening is done in a series circuit, since the phones are in series with B plus, but in the next circuit a parallel output is shown, a fixed condenser being connected from plate of the tube to output post.

When Wave Form Gets Poor

In the third circuit the audio frequency is made somewhat variable. Here an uncored transformer happens to be used, as the frequency control is made more extensive, although there are limitations here, as shall appear.

The grid leak and condenser are included as usual, the capacity higher than in previous instances, and the leak about the same. The leak value can control the tone. It so happened that about 5,000 cycles was the generated frequency, without any tone control.

If the leak is made larger the frequency is made lower, and finally the sound will be like motorboating, with very poor wave form. This is objectionable for all ordinary purposes, because of the unsteadiness of the output, and frequencies so low as to produce large voltage fluctuations render the audio oscillator of no value for modulating purposes. An output meter would be so wobbly, at the end of a receiver into which radio frequency is fed, with this modula-

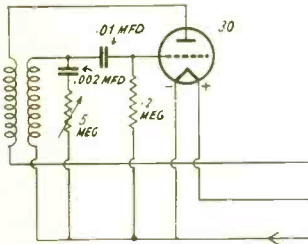

Sometimes one desires to have a source of variable audio frequencies. One way of doing this is to put a condenser in series with a high resistance rheostat. Although it would seem that the change must be continuously variable, actually there may be variation in distinct steps. Read the rheostat as .5 meg.

tion, that resonance could not be readily identified.

The grid condenser may be .01 mfd. as shown, the grid resistor of such value that the frequency is not so low as to create the condition of instability, and then the .002 mfd. condenser and the .5 meg. rheostat are put in the circuit.

Four Frequencies in Jumps

The frequency then will change, and in a given rig there were four distinct frequencies, about 5,000, 2,000, 1,000 and 500 cycles. Although the control is continuous the frequencies resulting did not change continuously but by jumps. However, there was a wide span, despite restricted selection.

It is practical to omit the rheostat and include instead a switch and various capacities of fixed condensers.

In the fourth diagram a method of introducing the audio tones into a radio frequency oscillator is shown. The r. f. tube's plate voltage is taken from the left-hand side of the .01 meg. resistor. This value is not important, so long as oscillations are maintained in the r. f. generator, and, if they are not, the resistance stated may be halved or even reduced more than that. The value of the resistance, however, has an effect on the audio frequency.

It can be seen that there is a limitation as to

the span of frequencies covered, also that some instability at low frequencies may be expected. Still, there is no range to speak of, and any considerable range would require a great deal of switching, and would lack continuity. The jump effect is hard to avoid. Also the calibration of the frequencies from constants inserted in the circuit is not easy, as some of the constants are masked by the tube and batteries contributing unobvious values.

Audio Beat Frequency Device

Different, however, is the audio beat frequency oscillator. This works on the principle of two oscillators, one fixed, the other adjustable as to frequency, the difference between the

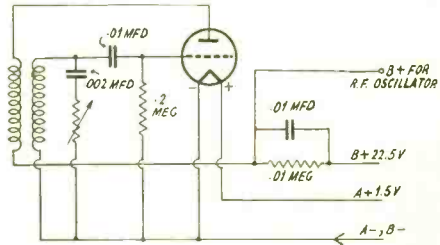

The circuit at left simply produces the frequencies, but suppose one desires to introduce them into an r.f. oscillator, that is, modulate a radio frequency oscillator with the audio tones. This may be done by interposing a resistor of from a few hundred ohms to 10,000 ohms, by passing it for all the radio frequencies, and introducing B plus into the battery r.f. oscillator at the lead shown. The higher the resistor the higher the percentage modulation.

two frequencies being the audio output. This device has the splendid advantage of constant amplitude of output for the audio range, lacking in the other type just discussed. Also, the frequency span is as wide as you want it, very simply accomplished. The wave form may be very good, but is difficult to maintain so at the low audio frequencies unless special precautions are taken. The intensity of the output is small, and for some practical purposes would require amplification.

The fifth circuit shows an audio beat frequency oscillator. The 30 tube at left is the fixed frequency r. f. oscillator and also the detector, from which the audio output is taken. If there is to be a combination use like this, the fixed frequency oscillator should be the one in the plate circuit of which the phones are placed.

The tube at right is the variably tuned circuit's generator.

If it is desired to encompass the span 50 to 10,000 cycles, then if the r. f. frequency is f , the variable radio frequency span is f to $f + 10,000$ or f to $f - 10,000$, values in cycles.

The Problem of the Dial

When the fixed frequency equals a terminal of the variable frequency, as it must, the condition of zero beat exists, but this has no prac-

(Continued on next page.)

(Continued from preceding page.)

tical value, save for zero adjustment. The lowest frequency to be calibrated is 50 cycles, and that is but a mite removed from zero frequency on the audio dial, since the ratio of frequencies is 200 to 1. Ordinarily in radio practice we encounter a frequency ratio of about 3 to 1, so there is about seventy times as much dial crowding.

Thus the advantage of encompassing wide span of frequencies conveniently is not an unmixed blessing. The frequencies are not widely separated on the dial. To atone for this somewhat dials are in favor that are either very large of themselves, or at least turn the pointer 270 degrees for 180 degrees condenser displacement.

A beat frequency oscillator using two type 30 tubes. There is enough stray coupling to provide the note. The tube at left, the fixed frequency oscillator, is also used as the detector, and the phones are in that circuit. The coupling is too tight if a frequency of 10 or fewer cycles per second can not be established.

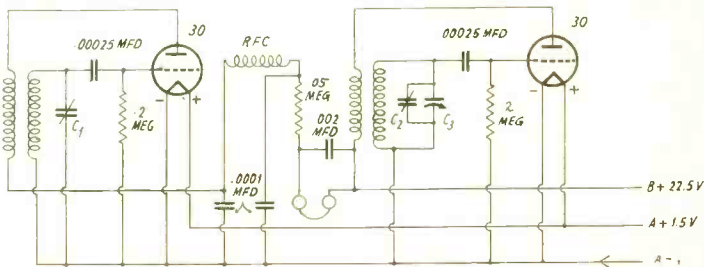

ment, or a 270 degree condenser is used with matched dial. These makeshifts are helpful but not solutions in any sense. With a ratio of 200 to 1, improving the dial separation by 50 per cent. simply reduces the ratio to 132 to 1, and we are used to ratios of 3 to 1 in receiver tuning, or even smaller ratios, and indeed bandspread.

Trick Dial

A proposed solution is to establish the circuit on a straight frequency line tuning basis, so that the changes of audio frequency will naturally be straight line also, and then use a clock type dial. This should have a large, fast-moving pointer for extreme circumference traverse, and a smaller slow moving pointer. There is a known ratio of movement between the two pointers, in one instance 16 to 1. Thus the fast moving pointer goes through 360 degrees 16 times to the slow moving pointer's travel through 180 degrees once. This is a mathematical ratio of 32. By selecting the frequency difference, end to end, to be a submultiple of 32, e.g., 50 cycles to 9,650 cycles, difference 9,600, each fast revolution equals a difference of $9,600/32$ or 300 cycles, and with 300 equal divisions, each division would equal one cycle. The slow pointer could then indicate even major frequencies, e.g., 50, 350, 650, 950, 1,250 cycles, etc., to 9,650 cycles, and the reading would be to one part in 9600.

Accuracy Discussed

However, there is no commercial dial of this type that permits such close accuracy, because the relative positions of the pointers may change in the best of them as one part in 1,800, so the accuracy can not be better than the change. Nevertheless the method represents an improvement. Refer to the article beginning on page

52 of the October issue, expounding this system.

Of course we must not expect too close accuracy from the audio beat frequency oscillator, not only for mechanical reasons, but also for electrical ones. The resultant tone is based on a difference between two frequencies. A small change in either of the causing frequencies will yield a large change in the resultant frequency, especially for low resultant frequencies.

It seems there is always some trouble concerning the low frequencies, little trouble concerning the high ones.

Since the variable r.f. oscillator has two terminal frequencies, and one of these is equal to the fixed r.f. oscillator, we have our choice of

using either maximum or minimum capacity of the variable for zero beating, by selecting the other frequency accordingly. If we select maximum capacity for the variable to zero beat with the fixed frequency, then as we turn the variable condenser we increase the frequency, and the high frequencies are at the small capacity settings. This is advantageous, since because with most condensers (all save s.f.l.) the high frequencies then become crowded, releasing needed extension for the low frequencies.

Sizeable Minimum Needed

The presence of r.f. oscillation at all is rendered possible by capacity, as well as other factors, but no capacity, no oscillation. Hence when the capacity is very small the circuit may be between oscillation and nonoscillation and actually shift quickly from one state to the other, simply referred to as frequency instability. Hence enough minimum capacity should be used to insure presence of adequate discharge capabilities of the condenser.

This condition is met when the zero beating is done at the low frequency, high capacity end of the variable, and of course substantial capacity should be present in the fixed frequency r.f. oscillator for the same reason of stability.

Besides the condensers already discussed, a very small variable should be across the fixed frequency oscillator, and panel controlled, for use as a zero adjuster. This is set at half capacity for first zero beating.

At this end of the audio tuning the difference in frequency is smaller than if the system were worked with zero beating at the minimum capacity end, but the adjustment can be made nevertheless, and besides error at the high audio frequencies will be small, because a given dif-

ference is now compared to a high rather than to a low frequency.

Other Example of Spreadout

The point has been made that if the zero beating is done with variable condenser at maximum the low frequencies are spread out, which is desirable. However, if a large capacity is put across the variable, the opposite holds true, the smaller capacity settings of the variable produce the better spreadout. This will be brought out in detail later.

The coupling has to be very weak between the two r. f. oscillators. In the diagram just discussed, as well as in others, there is no specific coupling shown. The reason is, sufficient stray coupling. A short length of wire may behave

a critical position for zero beat, and the first audio frequency heard must be a very low one. Using the two tube circuit with output transformer and volume control, it was actually possible to generate a frequency of five cycles. This is something you may count, therefore it is easy to verify. You get an accurate watch or synchronous electric clock and count the pulses for 30 seconds, beginning when the second hand is at 0 and ending just when it is at 30. Then you divide the number of seconds into the count and obtain the frequency with pretty good accuracy.

Zero Beat Adjustment

The next position obtained by careful adjustment was 40 cycles, and that was a micrometric

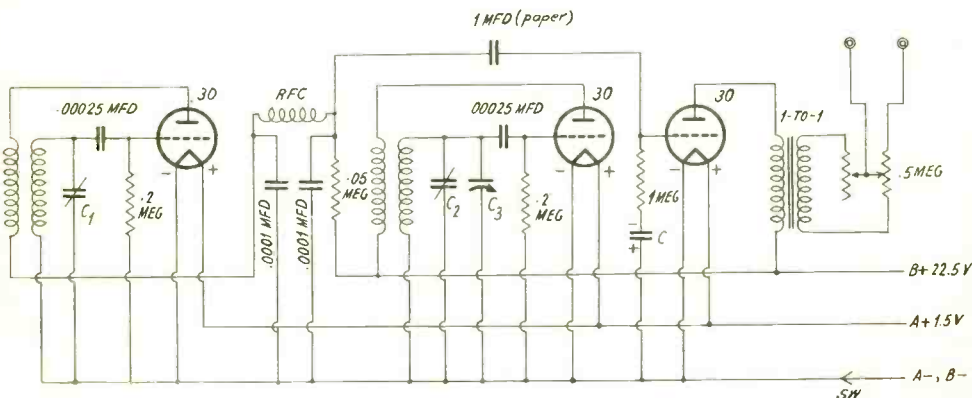

Here an audio amplifier stage is included, first, because the voltage output from an unamplified beat frequency oscillator may be too low for some purposes, and second, because the effect of the load to which the output is connected is then practically nil so far as frequency change is concerned.

as a sizeable impedance to the two radio frequencies to establish the mixing. The dry cell to a slight extent, the B battery to a large extent, will augment the coupling. Also, as the resistance need be only very low, seemingly sufficient capacity across these common impedances do not perform the bypassing expected. In one instance .05 mfd. across a common 1,000 ohms did not prevent the mixing. Besides, stray inductive fields, stray static fields and wiring capacity all act to create sufficient coupling, and the problem is one of keeping the coupling down. It is abundantly present without intention.

Discovery of Overcoupling

The presence of overcoupling is easily distinguished because then one establishes a broad zero beat. In fact, zero beat seems to extend to more than merely zero, or, to put it differently, zero beat is masked. There is too much of it and the first audible frequency may be 500 cycles or even 1,000 or 2,000 cycles. The measure of the pitch of the first audible frequency is a measure of the grossness of the overcoupling. It should be possible to establish a difference frequency of 10 cycles or so as test of small enough coupling.

When the coupling is small enough there is

dial. Ratio of knob to condenser shaft, due to planetary gearing and reduction ratio in the dial proper, was 250 to 1. Marking 50 cycles as one terminal frequency therefore was a little task, save for registering the zero position. It is zero position which is adjusted each time a measurement is to be made. It is not really possible to hear zero beat. Since the first frequency we can hear depends on one's ears, it may be 20 cycles or so, hence metering is advisable. The frequency may be put into an amplifier in the output circuit of which is a d. c. milliammeter of the undamped type, that is, full of wobble, and the frequency may be counted by observing the needle movement, and zero adjustment made when the needle stands approximately still. Getting real zero beat is a feat, so something as close to zero as the dial adjustment permits will be satisfactory.

Another method is to use an indicating tube. e. g., 6E5, biased to nearly zero angle. so that a. c. will show extension of the shadow angle. and feed some of the voltage of the changing frequencies to this tube. When the frequency is low enough the fluctuations may be seen, and when there is no fluctuation, after proceeding to lower and lower frequencies, the result may be taken as zero beat. It should be borne in mind that there is no

(Continued on next page.)

(Continued from preceding page.)

obtainable voltage at zero beat, or, if one exists, it is not something that can be taken out, by any present known means. Though the indicating tube will "stand still" at all frequencies higher than those for which visual distinction exists, a steady deflection may be expected.

Uses Discussed

Zero beat thus may be described as a form of rectification, though we are defeated for the time being from taking out the resultant d. c. It must be remembered that the d. c. would not be as pure as we desire. A slight wobble would result in a very low frequency, one constituting a ripple exceedingly difficult to filter out.

Without amplification it is generally impossible to obtain the needle movement desired, as the meter will not respond to the small intensity of the changes, but after amplification the effect is considerable.

The audio frequencies produced by the methods so far discussed are for the development of voltage, for use in modulating a test

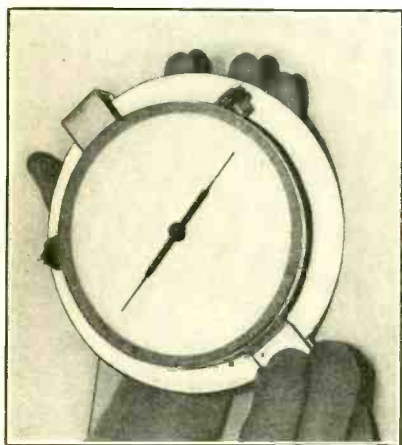

An audio frequency oscillator may be calibrated by getting the tuning curve in terms of degrees of a circle, protracting the curve on a diameter four times that of the intended dial (above), and then photographing down the drawing to dial scale size for actual use.

oscillator for instance, or input to an audio channel, but practically no power can be taken from them.

Calibration of the Audio

When it is necessary to modulate the final stage of a transmitter, for high level, high percentage modulation, the power rating of the modulator tube should equal the power rating of the final stage, because at 100 per cent. modulation as much power is required from one as from the other. If the modulator has a smaller power rating it may be used for low level modulation, meaning that a buffer tube may be modulated, instead of the final, or even the oscillator itself, although in transmitters of

modern design the modulation of the oscillator is generally avoided, if possible.

Aside from transmission, however, mere voltage is adequate. Besides modulation of a test oscillator there is supplying an audio amplifier that is to be checked. The output of the audio oscillator is connected to the input of the audio channel, and the indications of an output meter are noted. If the audio oscillator's output is connected to a succeeding audio stage, the gain of the first stage is equal to the lower second reading divided into the higher first reading. Even a d. c. milliammeter may be used, if the output tube has been calibrated as a vacuum tube voltmeter, so that the plate current readings may be converted to equivalent input a. c. voltage values.

Of course, for the audio generator to be of any real practical value it must be calibrated. If it is not calibrated at least one may select the lowest audible frequency one can hear, and also the highest one can hear, and changing the frequencies continuously from one extreme to the other, note whether the needle remains fixed, or varies much. Of course it will vary in nearly all instances.

So the calibration is undertaken.

Creation of Standard

There are numerous ways of approaching this problem, but for actual calibration purposes only one method, deemed the simplest within the means at any one's command, will be described. It consists of building one beat frequency oscillator to be used as standard, then calibrating the other from the standard, and using additionally some checking frequencies specially obtained, by means likewise at hand.

The two tube battery oscillator diagram may be used, with volume control and output transformer, but 90 volts of B battery should be used. The two r. f. transformers are equal, and are used with a nominal .00035 mfd. midline tuning condenser, single gang, of the type that closes to the right.

The two coils are honeycombs, of 3 millihenries secondary inductance, tickler about one-quarter the number of secondary turns, not critical. Actually the tuning condenser used had a capacity of .0004, and allowing for 20 mmfd. stray capacity, the frequency generated when the condenser plates were entirely enmeshed was 140 kc. This could be checked against a station at 560, 700, 840, 980, 1,120, 1,260 or 1,400 kc, tuned in on a receiver, with output of the generator couples to the antenna loosely, as by twisting the output lead around the antenna leadin for a few turns, or, if the station comes in weakly, by connecting the output of the generator to the receiver's antenna post, where the aerial leadin is also connected. At the generator a few turns around tube or coil will be sufficient, comprised of part of the coupling wire.

Determination of Fundamental

If no station of such frequency is receivable, use a station of somewhat higher frequency. For instance, if the station is 710 kc, then very close to maximum capacity there should be a beat, representing $710/5$, or 142 kc. The re-

sponses on the receiver when its dial is turned, generator not turned, will be separated by the fundamental of the generator. There would be beats with the seven stations enumerated in the preceding paragraph, if stations of all those frequencies were receivable. At least, try for another station that also will yield a beat, to verify the frequency. This is done by taking all the stations receivable and dividing them by factors from 5 to 20, listing them, and noting which stations have common harmonics. For instance, if 700 kc and 1,260 kc are receivable, there should be zero beat for each, using generator's 142 kc. If 710 and 570 kc are receivable, using 142 kc when zero beating its fifth harmonic with 710, and 570 kc is receivable, turn the receiver to 570, generator untouched, when a finite beat will be heard, because the fourth harmonic of 142 kc is 568 kc, and the station is 570 kc, so the note is 2,000 kc. These responses, at 710 and 570, are consecutive, and better facilitate checking.

With the low frequency established this way, and no trimmer condenser used, the high fre-

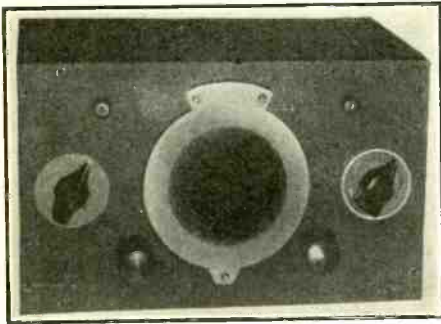

Few precision dials with readings of 180 divisions for a semicircle are obtainable. An excellent way to get an accurate protraction is to find the frequencies in terms of 0-100 for 180 degrees, using a true vernier dial (above) reading to one part in 1,000, and then multiplying the readings by 1.8. The resultant will be in terms of degrees and fractional degrees of a circle.

quency terminal will be close to 500 kc, because the frequency ratio is about 3.6. There will be a receivable station with which generation near the minimum capacity of the condenser may be beaten.

Second Harmonic Examples

Thus, 760 kc would be used to check 380, with about one-fifth engagement of the condenser, 800 kc to check 400 kc, etc. Second harmonics of the generator are used. Thus the fundamental span is sufficiently checked. Indeed, if the low frequency terminal is approximately right, the high frequency terminal need not be checked, nor any other frequency.

The coil may be a problem, especially as it can not be wound save by those who have a honeycomb winding machine, but any coil of too much secondary inductance may be put in, the frequency at maximum capacity measured approximately by noting at what frequency set-

ting of a receiver a beat is picked up, and then the next consecutive response in the receiver, the generator fundamental frequency being equal to the repeated differences. With the constant difference too small, remove secondary turns until the proper frequency is generated, close to 140 kc.

Now put a .0008 mfd. fixed condenser, or a bank of smaller capacity fixed condensers in parallel to add up to .0008 mfd., across the tuning condenser, and there will be far lower frequencies, also great spreadout. The terminal frequencies will be about 83 and 100 kc. This is a difference of 17 kc.

The fixed frequency oscillator need not be considered until the low radio frequency span is calibrated. It so happens that 95 kc comes in with the tuning condenser just a bit more than at half way in. This is the nominal 350 mmfd. variable condenser. The frequency can be checked for position on the dial by getting zero beat with WJZ, 760 kc, and again with WMCA, 570 kc, both of which frequencies are multiples of 95, and apply to residents in and about New York City. Residents elsewhere may use other proximate frequencies. The tabulation of receivable stations, reduced to subharmonics, will disclose which ones will be serviceable to the reader. He will thus get as many points as he can, probably on a 0-100 dial, preferably with a true vernier type 0-100 or 100-0 dial in 180 degrees reading to one part in a thousand. Multiply each numerical value (not frequencies) by 1.8 and then draw a curve, which will relate the frequencies to the degrees of a circle. The curve paper, or plotting paper, or graph paper, should be large, say, a couple of feet each way.

Writing in Audio Frequencies

When the curve is drawn the points to be registered on the dial are marked on the curve in terms of resultant audio frequencies. Some receivable stations will beat with tenth harmonics of the generator, e. g., 850, 860 kc, etc., with 85, 86, and the whole scale accounted for finally by the assistance of the curve, which supplies missing frequencies, but the spreadout will be far greater at the high frequency end than at the low, due to the large trimmer capacity, therefore it is advisable to select 90 kc, which represents about two-thirds of the dial scale or capacity of the tuning condenser, establish the fixed frequency oscillator later at this frequency, so that the resultants will be 0 to around 10,000 kc. This is true because the fundamentals used are 90 to 100 kc, a difference of 10 kc, or 10,000 cycles. Actually 100 kc may not be reached quite, although 9,990 kc will be.

So when the calibration is completed, instead of writing down the real frequencies of the curve, write down 0 for 90, 50 for 90.5, 100 for 91, 150 for 91.5, etc., until you reach 9,990 or 10,000 kc. Then when instituting the fixed frequency oscillator do so with a 50 mmfd. front panel condenser across this secondary, set half way and adjust extra internal trimmer. Zero beat when the other or variable generator is at position marked 0.

(Continued on next page.)

Lifting Standard Audio Frequencies Right Out of the Air!

HEREWITH is tabulation of resultant audio tones, three of them below 1,000 cycles, and each 1,000 group represented by at least one frequency, up to and including 10,000 cycles. Metropolitan New York stations were used, but the method can be applied to other locations, although hardly with as much diversification as the metropolitan district affords. However, only a few of the 26 local stations are used in obtaining the data on which the tabulation is based.

The calculations were made on the basis of moving the receiver dial. Thus, a station is tuned in, frequency designated in the first column (left), and the generator coupled to the set has to produce the frequency designated under "Generator kc." Then the set is dialed to the next listed station, the resultant audio tone being given at right.

The frequency required of the generator is simply zero beat at the frequency designed in the second column. Any error in reading, etc., will be due to inaccuracy of the generator calibration, as the stations' crystals are used for checking, and if there is anything wrong it is in the generator and not in the station. So the repeated odd frequencies in the generator column are not confusing. The harmonic of generator used may be determined by dividing the figure in the second column into the figure in the first column. From the tabulation a complete curve from 333 to 10,000 kc may be plotted, and from the curve the even values desired may be obtained, e.g., 1,000, 2,000, 3,000, etc., and integrals. For lower than 333 cycles it will be necessary to resort to other means, such as line hum, or establish two different audio frequencies, using two setups, and combine them for the lower resultant frequency. Thus, beating 2,000 and 2,100 cycles will yield 100.

This is the first tabulation of its kind ever published:

Tune in Station Kc	Generator Kc	Turn Receiver to Station Kc	A. F. (cycles)
710	118.333	1180	333
1450	131.888	660	560
710	50.714	660	718
860	50.588	760	1,130
570	71.25	710	1,250
860	66.154	660	1,540
710	142	570	2,000
710	71	570	2,000
570	142.5	710	2,500
860	50.588	810	2,592
810	73.636	660	2,724
940	62.666	570	3,006
1450	76.315	760	3,150
760	50.666	570	3,260
860	71.666	570	3,328
570	95	860	3,300
860	143.333	570	3,333
570	81.428	810	4,280
570	95	660	4,284
660	94.286	570	4,284
860	95.555	760	4,440
570	142.5	860	5,000
940	188	570	6,000
570	95	940	6,000
940	94	570	6,000
710	142	860	6,665
860	143.333	710	6,665
810	50.625	760	6,043
660	82.5	570	7,500
810	115.714	570	8,570
570	114	810	8,570
660	50.761	570	9,629
1450	290	570	10,000
1450	72.5	570	10,000

Calibration of a Dial for Audio Tones

(Continued from preceding page)

While it is not the highest form of accuracy to trust to the ear for zero beat, the practice serves a purpose, since it permits a zero adjustment otherwise not present or practical, and does improve the accuracy, compared to complete neglect of the precaution.

To calibrate the dial itself, use a protractor on a large board, draw a circle four times the dial scale size, and mark in the bars for frequencies, 50 to 10,000, from the curve sheet. Then photograph the drawing down to dial scale size and insert the print in place of the present scale.

The device just described could itself be used as a beat oscillator, but the range for full displacement is 17,000 kc, perhaps needlessly high. Therefore the same sort of coils and main tuning condenser are used in the second

model, the one to be calibrated from the first, the parallel capacity, instead of being .0008 mfd. is .0025 mfd. or thereabouts.

The complete 180 degrees of condenser rotation will encompass then slightly more than 0-10,000 cycles, as the actual total required maximum would be .00348 mfd., consisting of .0004 of the tuning condenser and .00294 total added capacity.

NEW BRUNO CATALOGUE

A new catalog has been issued by Bruno Laboratories, 22 West 22nd St., New York City, illustrating their line of velocity microphones for amateur, experimental, public address and broadcasting use. Methods used to attain improved tone quality and sensitivity are described. The entire line of microphones represents a complete redesign by the engineer.

Superheterodyne Alignment

All Bands, Both Levels, All Receivers

By Herman Bernard

FOR peaking the intermediate amplifier of a superheterodyne, short circuit the antenna and ground posts of the set, and connect a signal generator to the control grid of the modulator tube. The generator is set at the frequency at which the i. f. channel is to be peaked. Turn the setscrew of the grid circuit condenser of the i. f. coil next to the second detector until response is loudest, or greatest indication is obtained from an output meter connected across speaker voice coil.

If there has been a considerable increase turn down the attenuator of the signal generator until there is a low reading on the meter, or small aural response. Then tune the condenser across the grid of the next coil. If there is a third coil, tune its grid, also.

Value of Attenuator

As volume or other indication increases, reduce the generator's output so that only enough indication is present to serve the purpose. Thereafter do not disturb the condensers across the grid windings, but slightly vary the plate condensers, in the same sequence as before, that is, from "back" of channel to "front," to determine if response is increased. If it is, then leave the condensers at the peak positions, otherwise restore them as they were. If the channel is subject to automatic volume control it is particularly important to feed a very weak signal from the generator because a.v.c. tends to mask resonance when strong input is fed to the channel.

For the padding, starting with the broadcast band, remove the short from antenna and ground posts of the receiver, remove the antenna lead-in connection from the set, connect generator output to antenna post of set, and ground post of generator to ground post of set.

Generate the frequency recommended by the set manufacturer for tying down the high frequency end of the broadcast band, usually 1,400 to 1,500 kc. If no frequency is recommended, use 1,450 kc. Turn the receiver dial until this is tuned in most strongly.

Application to Frequency Dial

If the indication of volume is very large, as it may be if the generator is modulated, remove the generator connection from antenna post, and simply wrap the wire around this post for a few turns, close to the conductor part of the post.

If the receiver is frequency calibrated, have the dial read the frequency you are using for testing, and adjust the trimmer on the local

oscillator until response is maximum. Two trimmer settings produce maxima. Use the one incurring the smaller capacity.

In all superheterodynes the oscillator frequency is intended to be higher than the signal carrier frequency, and the difference is equal to the intermediate frequency. Since the intermediate frequency is usually only about one-third of the tie-down frequency at the high frequency test position for even the broadcast band, it is practical to set the local oscillator trimmer at a frequency higher or lower than the station carrier frequency, and either position yields a strong response. *Be sure to select the smaller trimmer capacity for the local oscillator that yields this strong response.* The other setting makes tracking impossible and ruins performance.

This same advice about selecting the smaller oscillator trimmer capacity applies to all bands on all superheterodynes.

The Antenna Effect

If there is no frequency calibrated dial select a position about 8 divisions out of 100 removed from the minimum capacity position of the tuning condenser. Next align the trimmer on the modulator tube, or section tuning the modulator, if a combination mixer-oscillator tube is used, then move forward likewise to r. f. stages.

The antenna adjustment is the last one and should be made with antenna reconnected, and signal generator then may not have to be connected to the receiver directly, but simply worked with its output lead near, or loosely wrapped around, the lead-in wire. This trimmer adjustment takes into consideration the antenna capacity as reflected in the secondary and the trimmer may have to be wide open. If small difference is noted until trimmer, pressed far down, simply reduces sensitivity, leave the trimmer wide open.

Next select the generator frequency recommended by the manufacturer for the low frequency tie-down of the broadcast band, usually around 600 kc. and if not stated, use 600 kc. The series padding condenser of the local oscillator in the receiver is now checked by noting response when the set dial is turned to pick up the generator output.

"Rocking" the Condenser

The series padding condenser is increased, then decreased, in comparison with the original, while the condenser is "rocked" this and that side of the original setting, for 15 divi-

(Continued on next page)

(Continued from preceding page)

sions or so out of 100, until that setting is found which yields greatest output.

The series padding condenser may be turned all the way in or all the way out, and then the whole condenser gang is "rocked" this and that side of the position originally found, while the capacity of the padder is adjusted bit by bit until maximum is found.

In practice maximum asserts itself only in comparison to a decline that sets in as the series capacity change is continued, so return to the prior setting that afforded maximum output. This setting has to prevail regardless of what frequency is read on a set's frequency calibrated dial.

Return to the high frequency position and adjust the generator for this. It may be necessary to readjust slightly the local oscillator trimmer, because of the small effect of a new series capacity value on the effective capacity at the high frequency test position.

The lowest frequency short wave band is adjusted usually by a trimmer at the same dial position as for the low end of the broadcast band. If the same parallel trimming is used on short waves there can be no further adjustment, and the same comment then holds for all bands. There may not be any series padders, hence no adjustments, for the short wave bands following the second, or even following the first one.

Independent Trimmers

If the coils have independent trimmers for short waves, adjust near the high frequency end, and any series padding condensers near the low frequency end, by the same method as already outlined.

If the receiver is very sensitive it is sometimes sufficient to work the generator without any external coupling to the receiver, as enough generator energy is picked up by the antenna leadin to supply the response.

If the generator is not modulated the checking may be done by connecting a d.c. milliammeter in the detector anode (plate) circuit. For diodes with 0.5 meg. load resistor, or thereabouts, a meter of 1 milliamperer sensitivity will get by, but .5 milliamperer sensitivity is better. Maximum needle deflection is the test.

Image Responses

There is another important consideration, and that has to do with image responses. Very little, if anything, can be done to correct for a poor image ratio, that is, strong image response, but one may use the image for verifying the frequency of tie-down, especially on short waves. It will be remembered that the series padding condenser may be the only controllable factor on short waves, and it is important here, too, to adjust for the desired signal and not for the image.

To do this work understandingly it is necessary to know what the image is, both theoretically and in concrete, practical values. By definition the image is the response obtained from a frequency higher than the intended one

by twice the intermediate frequency. The reason for the image is plain when one considers that the mixer does not perform any thinking operations, but simply behaves according to electrical laws.

The Two Frequencies

If the local oscillator in the set is at some proper frequency, and there is a desired response from a generator, this may be called the object frequency of response. The local oscillator in the set is higher in frequency than the generator output. It is possible to get a response at a higher generator frequency without molesting the receiver.

The generator frequency is higher than the local oscillator frequency by the amount of the intermediate frequency. This higher generator frequency is the image. Since in one instance the same oscillator frequency is higher than the generated frequency used for testing, and in the other instance the same oscillator frequency is lower than the supplied frequency, it is obvious that the difference between the object and image frequencies is twice the intermediate frequency.

From this clue it is possible to go forward with an image response test. Remembering that the image is undesirable, but inevitable, the goal is to keep it as low as possible, and the only known method of doing this is to use sufficient tuned radio frequency amplification. This, however, is a matter of design, and while we are dealing now only with measurement, it is not amiss to point out the advisability of t. r. f. ahead of the modulator, at least two stages preferably, or the use of a pre-selector, which furnishes the needed t. r. f.

Images and Decibels

Now, after any high frequency check on the broadcast band, by oscillator trimmer adjustment for loudest response, with the smaller trimmer capacity to produce the result, note the frequency, add to that frequency twice the intermediate frequency, and you ascertain the image frequency. Suppose the tie-down frequency is 1,450 kc, the intermediate frequency is 465 kc. The oscillator happens to be working at 1,450 + 465 or 1,915 kc. Twice the intermediate frequency is 930 kc. The image frequency is therefore 1,450 + 465 or 2,380 kc. A strong signal of 2,380 kc, fed to the receiver, will produce a response, though the set is primarily tuned to 1,450 kc and a comparison of this response to a response due to feeding the same amplitude of 1,450 kc to the receiver yields the ratio of object frequency to image frequency, and is known as the image ratio. The expression is usually given in decibels. So if the image is 15 decibels down it is considered an excellent rating, especially at the high frequency end of the shortest wave band. The decibel notation is a logarithmic ratio of the output voltages.

Image for Verification

The test is more readily applicable to the low frequency tiedown of short wave bands, where the series condenser is manipulated. A mistake

Band Pass Alignment of I.F. Channels

(Continued from preceding page)

in frequency selection may be avoided or remedied, because there should be a strong response at the intended frequency of input, and, increasing the generator frequency by twice the intermediate frequency, another but weaker re-

cathode ray oscilloscope would be better, and for flat top peaking is absolutely essential. The real high fidelity receivers must be flat-topped with the cathode ray tube. Manufacturers' directions should be followed in such circumstances.

Coils of this type are used in a signal generator such as would be used in following the peaking directions. Five or more bands are covered. The proximity even of adjacent band inductances does not produce any dead spots. A front panel switch would be used for selection of the proper band, dial on condenser turned to read the required frequency.

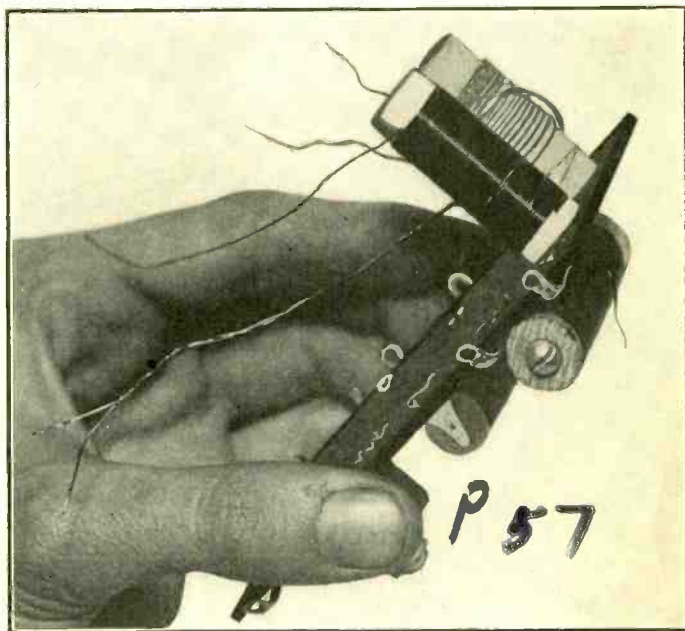

sponse would be heard. If necessary, increase the output from the signal generator so that the image response will be great enough to be readily discernible. The verification of the intended setting is obtained in this way since the proper frequency selection is verified by spotting the image at a frequency higher than the normal one by twice the intermediate frequency. The accuracy of the frequencies is dependent on the calibration of the generator. It is therefore advisable to have a generator of good accuracy.

Double Humps

The foregoing was concerned with peaking, or establishment of sharpest resonance. Some receivers have i. f. channels intended to be double humped for a bandpass effect. Others are designed for a relatively flat top, or broad tuning, to pass a certain band width. Double hump tuning can be accomplished by the foregoing practice, by setting the grid tuning condensers for maximum response at a prescribed frequency and plate tuning condensers at the other prescribed frequency, or by staggered peaking in two or more stages. Really a

667-665
All Circuits We Print Can
Be Readily Duplicated

ALL parts for circuits described in RADIO WORLD constructionally are obtainable. Any information concerning parts may be obtained by addressing Information Editor, RADIO WORLD, 145 West Forty-fifth Street, New York, and enclosing stamped, addressed envelope.

Moreover, all of the circuits have been constructed and tested, and the photographic illustrations should be followed as closely as possible, as location of parts sometimes plays an important role in determining results, especially on short waves. —EDITOR.

SHEDS LIGHT ON LIST PRICE

Economics Teacher: What is the meaning of list price in the radio business?
 Student: List price is the price nobody pays.

Three New Metal Tubes

6Q7 (75), 25A6 (43) and 25Z6 (25Z5)

By Woodring Lawrence

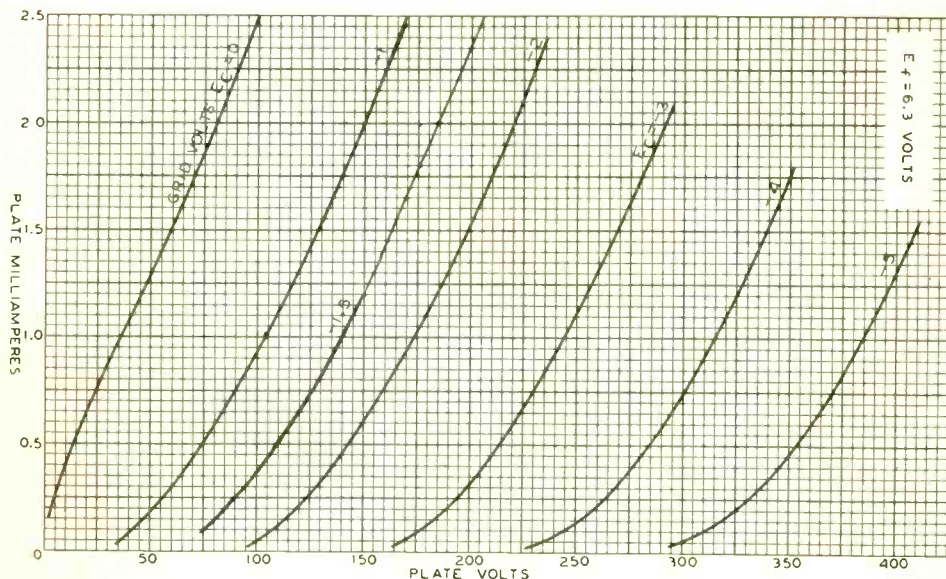

Curves for the triode unit of the 6Q7, as supplied by RCA Radiotron Company, Inc., except that the -1.5 volt bias line has been added.

THREE new metal tubes are announced: the 6Q7, similar in application to the glass type 75, and consisting of a duplex diode and a high mu triode in one envelope; the 25A6, a power amplifier pentode similar to the 43 glass tube; and the 25Z6, equivalent otherwise to the 25Z5. The 6Q7 is the first dual tube of the metal series.

The curves on the triode of the 6Q7 are given herewith. From these it is possible to determine the characteristics of the tube. The results should tally fairly closely with the tentative data on characteristics, especially the amplification factor, as the test changes do not have to be so very small. For the mutual conductance, or plate-cathode transconductance, and for the plate resistance there may be some divergence, due to inability to read very closely from the curves the required small differences.

Finding Mutual Conductance

Take the line marked 1.5 volts negative bias. This represents the bias selected for 185 plate volts. There is reason for this, since for small input a.c. voltages the operation will be linear. This will be considered later. Now let us find the mutual conductance.

A small difference in plate current is compared to a small causing change of grid bias to ascertain the mutual conductance. Therefore

$$G_m = \frac{I_{pd}}{E_{gd}}$$

where G_m is the mutual conductance, I_{pd} is the small difference in plate current, and E_{gd} is the small difference in negative grid voltage that produces the plate current change. The only other consideration is that the plate voltage is maintained constant.

Therefore let us select a small difference in plate current. The plotting paper is on such a scale that the plate voltage difference between adjoining perpendicular lines, read on the horizontal, is 5 volts. Starting, say, at 185 plate volts and 1.5 negative grid volts, the intersection being at 2 milliamperes, let us change the grid voltage by the distance between two adjoining lines. This difference is one volt for 14 spaces, or $1/14$ volt for the space between adjoining lines, and for two lines is $1/7$ volt, or .143 volt.

Amplification Factor Precisely Determined

The statement has been made that the operation is linear, that is, for a given change of grid

voltage there is a proportionate change of plate current, hence moving the grid voltage over two squares justifies moving the plate current up two squares, equals an increase of .1 milli-ampere. This takes a little liberty with precision, because a given bias line is used, equivalent to a small plate voltage change. So the mutual conductance turns out to be .0001-.143 or .0007 mhos. Multiply by a million to express in micromhos, equals 700 mmhos. The tentative characteristic data give 800 to 1,200, dependent on operating conditions.

The amplification factor, or mu, is the ratio of the difference in plate voltage to the difference in grid voltage required to maintain the plate current to constant. Thus $\mu = \frac{E_{pd}}{E_{gd}}$

where μ is the amplification factor, E_{pd} is the plate voltage difference and E_{gd} is the grid voltage difference. It is necessary to maintain the grid voltage difference small. The absolute plate voltage difference will be much larger, as the ratio of enlargement is the mu.

If from the operating point we move across seven spaces that equal a grid voltage difference of .5 volt we find that from the plate volts calibration below this equals a difference of 35 plate volts, so the mu is 35-.5 or 70. It is just a number. The tentative characteristics give the amplification factor as 70.

The remaining important consideration is the plate resistance. All radioists know that resistance equals voltage divided by current. The same general condition prevails now, but we do not desire to know the d.c. resistance, rather the a.c. resistance. Nevertheless let us find the d.c. resistance just to compare the two values.

The d.c. resistance is equal to the plate voltage, 185 volts, divided by the plate current, .002 ampere, so equals 92,500 ohms.

The A.C. Plate Resistance

The a.c. resistance we are seeking, or plate resistance as it is simply called, the qualification a.c. being understood, is equal to the ratio of a small change in plate voltage compared to the resulting change in plate current, with grid voltage maintained constant. If we change the plate voltage 5 volts, the difference between two lines, we change the plate current .0001 ampere, so the plate resistance equals 5/.0001 or 50,000 ohms. The tentative chart gives 58,000 for the 250 volt plate, 3 volt negative grid operating point.

The formula for a. c. resistance is $R_p = \frac{E_{pd}}{I_{pd}}$

Actually the values of the foregoing are obtained by measurement, rather than from dissecting curves, especially as the inability to disclose close differences in the curves yields somewhat erroneous answers. These show up as mild contradictions. For instance:

The mutual conductance may be approximately obtained from the ratio of the plate resistance to the amplification factor. The formula for

an answer in micromhos is: $G_m = \frac{\mu}{R_p}$

We have computed the plate resist 50,000 ohms, the mu checks perfectly therefore the mutual conductance is 70/50,000 or 1,200 mmhos. The Gm error is serious when results are computed from a curve, and particularly when the curve does not enable plate current readings for small differences in bias voltages, and a linear operating point has to be selected.

Linear Operating Point

The straight line operating point would be particularly desirable in a high class audio amplifier into which small input was introduced, also for a stable oscillator, where the amplitude of oscillation was small at all settings, and if more output is needed, amplification is introduced. The limits for the 1.5 volt bias, 185 plate volts, are 3 and 1.5 milliamperes, with bias adjusted to 2 milliamperes at no signal.

A one volt bias may be introduced by using a polarizing cell, through which no plate or grid current should pass. The grid return would be interrupted by this cell, and bypassed by a condenser of .0005 mfd. or larger capacity. With 140 volts on the plate, the plate current would be 1.75 ma, and the grid swing could cause plate current changes within the limits of 2.5 and 1 ma. The reason why the extension of the limits for the higher plate voltage was not suggested was that 2.5 ma are as much current as one should pass through the tube.

ALL WAVE COILS

Here are tested coil data for .00035 mfd tuning:

The bands are A, standard broadcast; B, intermediate short waves; C, foreign short waves. Padding for A consists of a .00025 mfd. fixed condenser across which is a 120 mmfd. variable. For B use .00097 mfd. fixed; for C, .00185 fixed. The two odd fixed capacities may be built up of parallel fixed values the sum of which equals the requirement. The winding data for shielded coils, tight winding, except as noted, are:

Band	Coil	Turns	Wire
A	Osc. Pri.	40	#32 E.
A	Osc. Sec.	78	#32 E.
A	Ant. Sec.	104	#34 E.
A	Ant. Pri.	22	#30 DC
A	R.F. Sec.	104	#34 E.
A	R.F. Pri.	40	#32 E.
B	Osc. Sec.	28½	#24 E.
B	Osc. Pri.	14	#30 DC
B	Ant. Sec.	29	#25 E.
B	Ant. Pri.	26	#30 DC
B	R.F. Sec.	29	#25 E.
B	R.F. Pri.	55	#32 E.
C	Osc. Sec.	8½	#24 E. Double Spaced
C	Osc. Pri.	5	#30 DC
C	Ant. Sec.	9½	#24 E. Double Spaced
C	Ant. Pri.	28	#29 E.
C	R.F. Sec.	9½	#24 E. Double Spaced
C	R.F. Pri.	38	#32 E.

Tubing 1 inch outside diameter ¾ long.
E represents enamel covering.
DC represents double cotton covering.

Propagation of Ultra-Short Radio Waves

By Charles R. Burrows

Radio Research, Bell Telephone Laboratories

ULTRA-SHORT radio waves have the distinct advantage, where portability of equipment is a factor, that the dimensions of the apparatus required are relatively small, since these depend directly on the wavelength used. Waves of such short lengths, eight meters or less, are also not ordinarily returned to the earth at long distances by reflections from the upper atmosphere and therefore do not cause interference with stations in distant cities.* For these reasons police cars, for example, can advantageously employ ultra-short wavelengths for communication with headquarters and short over-water circuits like that across Cape Cod Bay between Provincetown and Green Harbor, Massachusetts, become practical by their use.† These and the possibility of many other applications are making it increasingly important to obtain a considerably fuller knowledge of the transmission characteristics of very short waves.

Many of the properties of ultra-short waves are analogous to those of light. The concepts of reflection, refraction, diffraction and wave interference may fruitfully be borrowed from optics and applied directly in predicting the propagation characteristics of ultra-short waves. In simple cases these predictions are closely checked by experimental observations; in more complicated cases experiment indicates

* *Bell Telephone Record*, November, 1933, p. 66.

† *Bell Telephone Record*, October, 1934, p. 34.

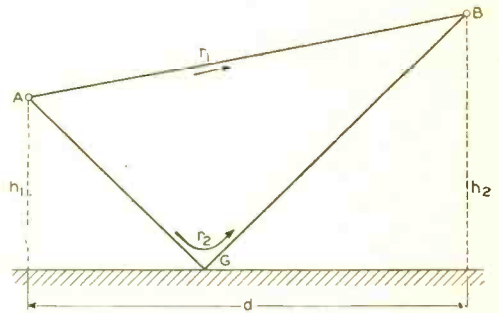

Fig. 1—In the propagation of ultra-short waves over level terrain, energy is propagated both directly as indicated by r_1 and by reflection at the ground as indicated by r_2 .

that some factors may enter which are at present undetermined.

The propagation of ultra-short waves over level terrain can be explained on the basis of the phenomenon of reflection alone. The waves may be regarded as radiating from the transmitting antenna at some definite point above the ground and the field produced at the receiving antenna as the sum of two waves: one propagated directly between the two antennas, and the other by reflection at the ground as shown in Fig. 1. On this basis the re-

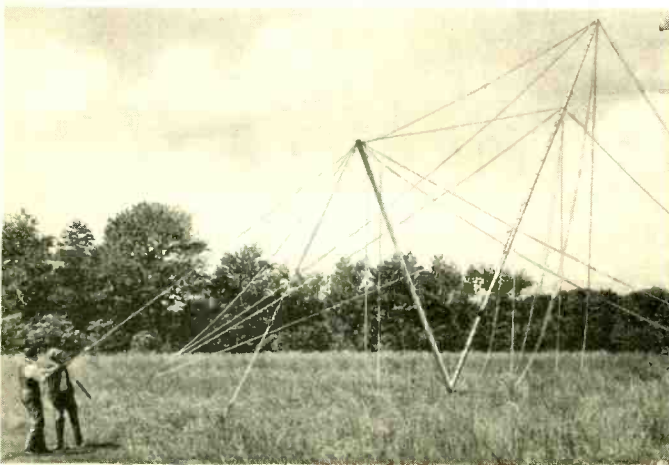

Fig. 2—This portable antenna mast is in three sections so that it can be carried on the side of a truck. Two men can assemble and erect the eighty-four-foot structure in an hour.

ceived field intensity can be shown to be equal to that which would result in free space multiplied by a certain factor. This factor within limits is proportional to the product of the two antenna heights, and inversely proportional to the product of the wavelength and the distance between the antennas. These relationships have been confirmed by a series of experiments conducted in southern New Jersey with the aid of the equipment shown in the accompanying illustrations.

Applied to Practical Cases

The results are directly applicable to practical cases of ultra-short-wave transmission over level land, between two points close enough to permit neglecting the curvature of the earth. They show that the transmission with antennas which have the same configuration and dimensions, measured in wavelengths, is independent of the wavelength used. This means that small antennas can be used, for example, in mobile equipment, without decreasing the efficiency by transmitting on very short wavelengths, since the actual size of the antennas for a given output decreases with the

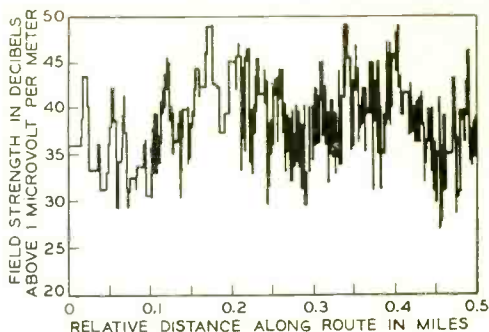

Fig. 3—These typical large field-strength variations were recorded while driving through the business district of Boston at about a mile and a half from the transmitter.

wavelength. On the other hand, the efficiency of transmission of antennas of a given size can be increased by decreasing the wavelength used.

(Continued on page 53)

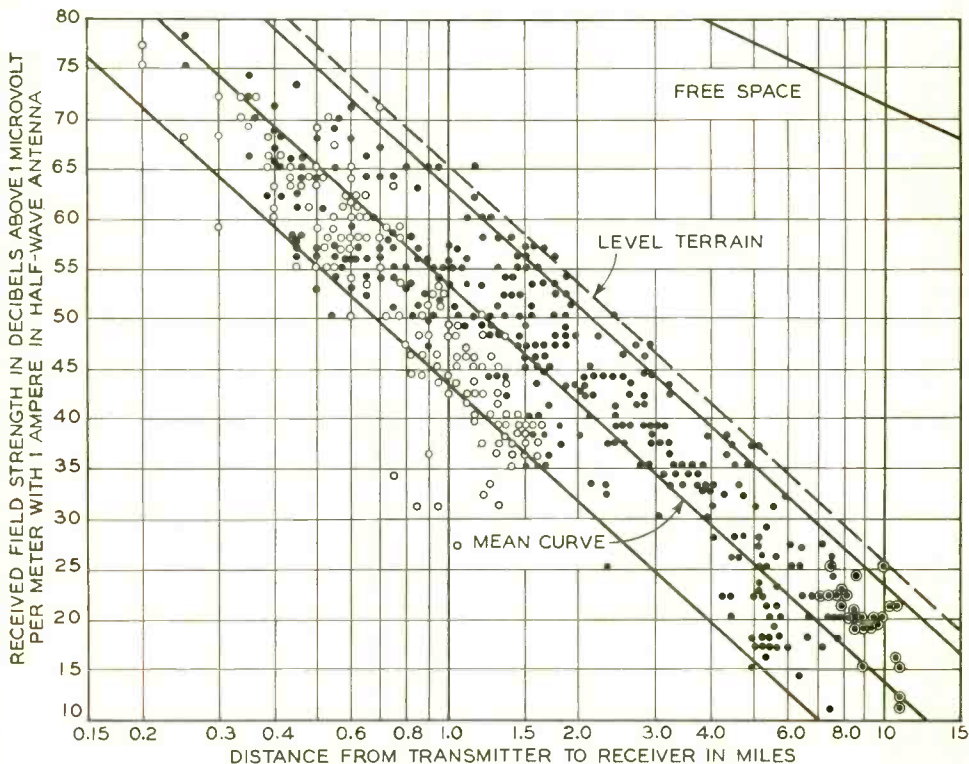

Fig. 4—Averages of field strengths observed at various distances from the transmitter in Boston are shown by open circles (business areas) and solid circles (residential areas). The upper two straight lines show the field strengths which would be observed in free space, and over level terrain with no buildings. The fact that the line representing the mean of the observations is parallel to the level terrain curve indicates that the buildings introduce an attenuation which on the average is independent of distance.

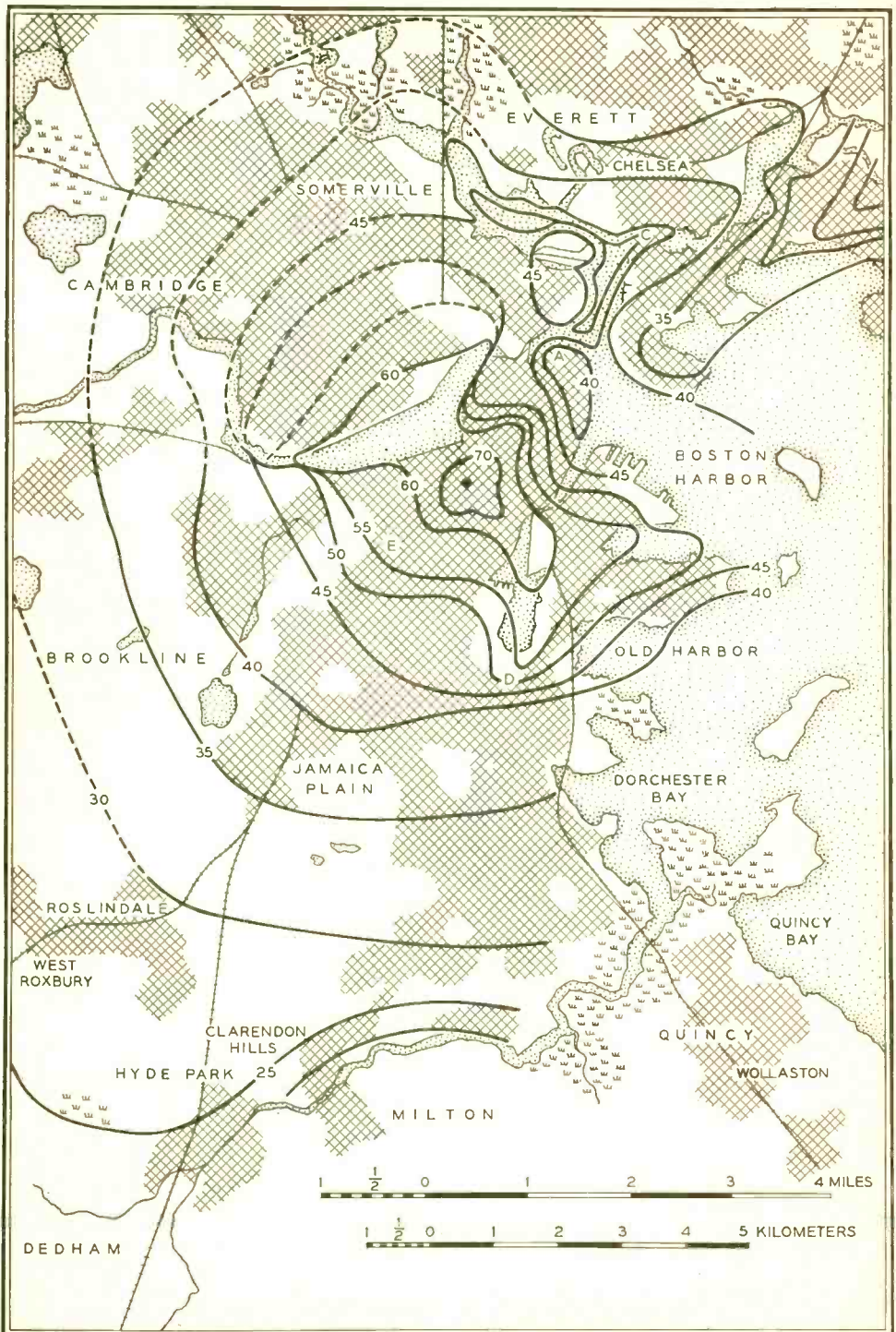

Fig. 5—A field strength map for ultra-short-wave transmission in Boston. The contours give the field strength in decibels above one microvolt per meter with one ampere in a half-wave antenna. Dotted lines represent plausible values in unexplored regions.

The propagation of ultra-short waves within a city, as in police communication, is complicated by the effects of buildings, trolley wires and elevated structures. As an automobile with a receiver is driven along a city street,

not persist at greater distances, when the receiver is separated from the water by more land, indicates that the influence of the water is strictly local. The phenomenon can be explained by observing that the higher conduc-

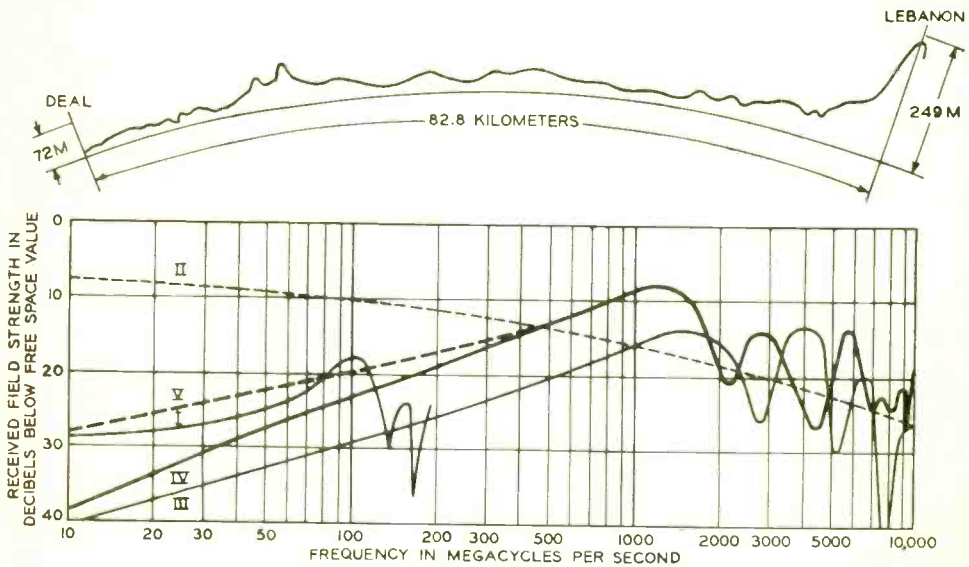

Fig. 6—Profile (above) of the "non-optical" transmission path between Deal and Lebanon, New Jersey, and (below) the frequency characteristics for the path as observed (Curve I) and as calculated assuming diffraction only (Curve II); perfect reflection and diffraction (Curve III); refraction, diffraction and perfect reflection (Curve IV); imperfect reflection, diffraction and refraction (Curve V).

the received field is found to vary from point to point in a very irregular way, as shown in Fig. 3. When the records of many such trips in a particular city are averaged, however, the data show greater regularity and point to some interesting relations.

The mass plot of these data (Fig. 4) shows the same inverse-square-of-distance trend which is characteristic of transmission over level terrain. Besides causing the individual points to deviate from the mean curve, the city structures moved the mean curve to lower values. This indicates that the average effect of the city structures was to introduce an additional attenuation which is independent of distance. Moreover, the mean field turned out to be approximately the same as that which would have been produced if all the city structures had been removed and the antenna brought to the same height above the earth as it had been above the average roof height.

Other Characteristics

The field strength contours in Fig. 5 reveal some other characteristics of ultra-short-wave transmission. The field is consistently higher when there is salt water immediately in front of the receiver, in the direction of the transmitter. The fact that the higher field does

not persist at greater distances, when the receiver is separated from the water by more land, indicates that the influence of the water is strictly local. The phenomenon can be explained by observing that the higher conduc-

Reflection Explanation Holds

In all these cases it has been possible to explain the results entirely in terms of reflection, and the interference between reflected and directly propagated waves. When ultra-short waves are transmitted over the path whose profile is shown in Fig. 6, however, the concepts of diffraction and refraction must be taken into consideration to explain the observed fields, on account of the presence of an intervening hill. The variations of field strength with frequency as observed experimentally under these conditions are shown in Fig. 6, Curve I. The shadow effect alone is not sufficient to explain the attenuation-frequency characteristics of the path, as can be seen from Curve II. Taking reflection also into account, and assuming that the ground is a perfect reflector, gives Curve III. Curve IV includes a correction for refraction in addition to those for diffraction and perfect reflection.

(Continued on next page)

15 Watt Power Amplifier

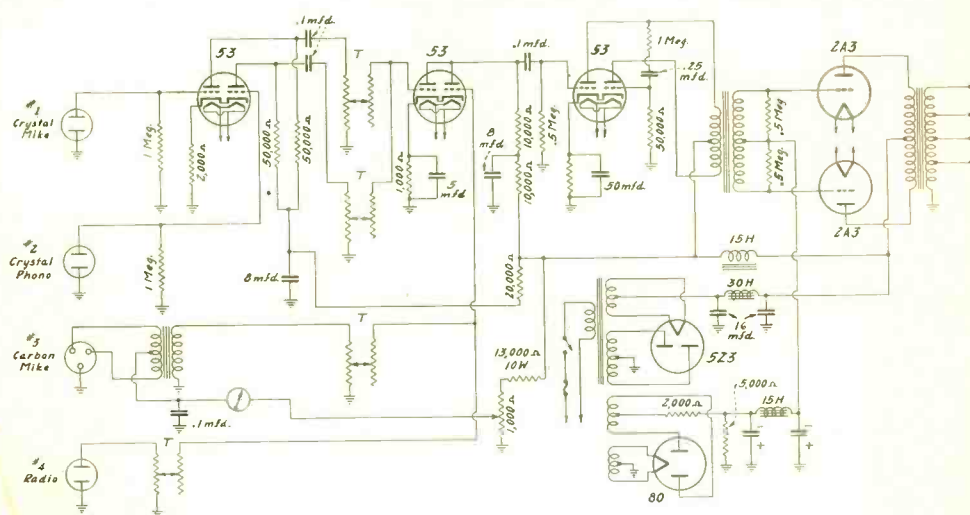

This 15 watt power amplifier has provision for four different inputs. They are a crystal microphone, a crystal phono pickup, a carbon microphone, and a radio tuner. For two of these, the two crystal devices, there are three stages of amplification before the power stage. The output of the crystal microphone is impressed on one half of the first 53 and that of the crystal pickup on the other half of the same tube. The combined outputs of these is impressed on one half of the second 53. There are independent volume controls for these two in the grid circuit of the second tube. The outputs of the carbon microphone and the radio tuner are impressed on the second half of the second 53. Thus for these there are only two stages of amplification before the power stage. The output of the microphone, which is of the double button type, is stepped up by means of a transformer before it is impressed on the amplifier. There is a volume control for each of these inputs in the grid circuit of the first tube used.

Propagation of Ultra Short Waves

(Continued from preceding page)

flection. Finally when the effect of imperfect reflection is considered the curve is raised at the lower frequencies as shown in Curve V. Evidently the latter curve satisfactorily reproduces the general trend of the observations shown in Curve I. The fact that maxima and minima occur in Curve I at lower frequencies than those predicted by Curve V indicates that the approximate theory of ultra-short-wave transmission upon which this curve is based neglects factors which become important above 100 megacycles. Further studies are in progress to determine more completely the physical characteristics of ultra-short waves and indicate more definitely their field of usefulness as carriers of the spoken word.

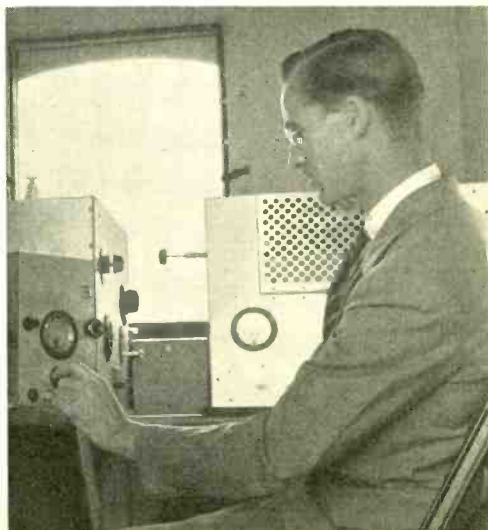

Fig. 7—Lloyd E. Hunt, who is shown with the ultra-high frequency transmitter used in these measurements, and Alfred Decino have taken important parts in these experiments on ultra-short-wave transmission.

A.B.C. of Meter Extension

Separate Posts Easiest Wiring for Novice

By Louis Kranz

MANY have a meter the use of which they would like to extend. Get a roomy box onto which may be fitted a panel holding the meter. Then one may put in the necessary resistors to extend the service of the instrument. Output posts are shown. Resistors across the meter enable higher current readings. Resistors in series with the meter permit higher voltage readings. When the higher voltages are read, the meter is used without shunts, that is, no external resistor across the meter, for most sensitive operation, or for full scale deflection minimum practical current should flow. This means greatest number of ohms per volt.

Some have an instrument, say a 0-10 milliammeter, and want to make it a 0-1 milliammeter. It can not be done.

Always the meter alone passes the same current for the same needle position. When the current range is extended the extra current simply flows through the shunt.

On the opposite page is a diagram for introducing series resistors, also a battery and a resistance for ohmmeter work. The simplest way to wire the rig is to use posts. Switching is handier in operation, but more complicated in wiring.

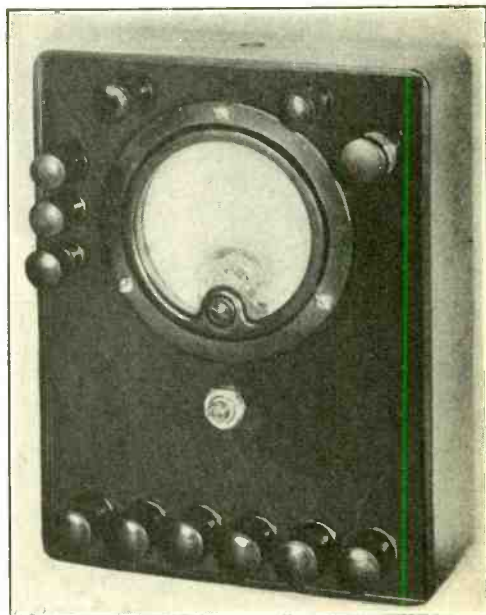

Front of a simple volt-ohm-ammeter.

Always Moved by Current

All meters are current indicators. If the scales are calibrated in terms of currents then the meter is called a current meter, ammeter, milliammeter or microammeter. If the scale is calibrated in volts the meter is called a voltmeter. If the scale is calibrated in resistance values the meter is called an ohmmeter. But it is always the same meter. What is different is its use.

The meter itself has a resistance of its own. For the 0-1 milliammeter this is usually low, 27 to 32 ohms in general commercial production. If the meter is much more sensitive, more turns of finer wire are used, and the resistance goes up. Even so, a microammeter may have an internal resistance of only 100 ohms, although some have an internal resistance of thousands of ohms.

Ohms Per Volt Solution

The minimum meter, considering cost and use, is the 0-1 milliammeter, and this is the basis of nearly all volt-ohm-ammeters. They cost more than less sensitive instruments, as a

rule, but there is no ducking the advisability, if not necessity, of having a meter that does not draw more than 1 milliamperes at full scale deflection.

When used as a voltmeter it has a resistance of 1,000 ohms per volt. This resistance for any meter may be determined by dividing the full scale deflection in amperes into the number 1, or, to state it mathematically, the ohms per volt rating is the reciprocal of the full scale deflection current in amperes. Since 1 milliamperes is .001 ampere, the ohms per volt for a 0-1 milliammeter is 1,001, or 1,000 ohms.

The meters considered measure d.c., calibrated in volts, currents or resistances. If a.c. use is intended, with the same meter, the practice in service work of using a separate meter of the high current type has disappeared, and instead the same d.c. meter as used for other purposes is equipped with a copper oxide or similar rectifier. This usually has an appreciable resistance, from 1,000 ohms up to 5,000 ohms or even more. Also, the use of a.c. is restricted to the commercial line frequencies, or frequencies not much higher, as the current

(Continued on next page)

(Continued from preceding page)
for the same applied voltage is different as one gets far away from the commercial frequencies. Thus radio frequencies cannot be measured although frequencies considerably lower than 25 cycles, the lowest commercial line frequency, might be measured with good accuracy.

Reactance Present

The reason why the current is not propor-

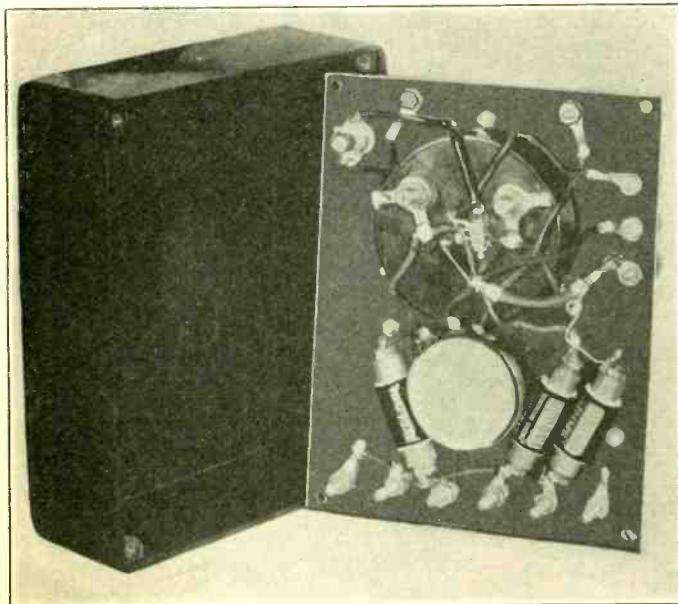

The inside view of an ohm-volt-resistance meter showing the back of the 0-1 milliammeter, the zero adjusting rheostat, and three multiplier resistances. No selector switch is used in this instrument because in the opinion of the builder binding posts were preferable. They are safer, for if there is a selector switch it is often turned from one setting to another without removing the voltage. The resistance meter in this case is the 45 volt range. An external battery of 45 volts is required for measuring resistances. High values of resistance can be measured accurately with this arrangement.

tional to the same voltages of vastly different frequencies is that the rectifier has capacity, and the difference in current flow at different frequencies for the same applied voltage reflects the behavior of a condenser. This condition that a condenser has, of passing different amounts of current for the same applied voltage, as the frequencies are greatly changed, is called the reactance of the condenser. Thus the rectifier has a reactance, that is, the rectifier is not a pure resistance.

Since in effect we would have a new resistance in the circuit not accounted for when the multipliers are selected for voltage ranges on the basis of 1,000 ohms for each volt of desired full scale, something has to be done as

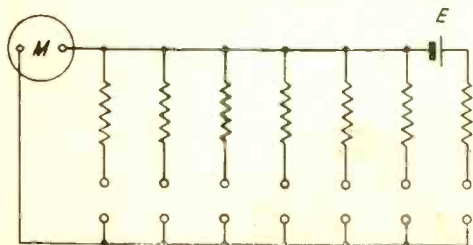

Ohm-voltmeter circuit.

compensation. The usual practice is to shunt the meter. Thus, the so-called universal meter has a sensitivity much higher on d.c. use than on a.c. On d.c. the meter alone then is much more sensitive than a 0-1 milliammeter but is shunted, and for a.c. the rectifier resistance is added to the multiplier resistors so that the same multipliers are useful. The ranges are the same but the a.c. and d.c. scales never track. Hence separate scales are used. Hence

if an unknown resistance rectifier is connected in circuit apply just half the desired full scale voltage with proper multiplier (series resistor) in circuit, and shunt the meter with a resistance that produces just half scale. Then check by applying full scale. The accuracy should be 5 per cent on a.c. for 2 per cent on d.c.

INTERMEDIATE FREQUENCY

Higher gain can be obtained with 175 kc intermediate frequency than with a higher one. Greater selectivity is possible. A receiver was designed for broadcast wave reception only, therefore a higher intermediate frequency is unnecessary. The stability of the circuit is better with the lower frequency for a given gain. The only drawback of a low intermediate frequency is an unfavorable image response ratio. Any signal frequency higher than the desired frequency by twice the intermediate frequency, in this case 350 kc, is likely to interfere, either directly or by a heterodyne squeal. This difficulty is avoided by sharp tuning in the radio frequency level and by close tracking of the oscillator with the tuner. No image interference trouble has been experienced with this receiver.

RADIO CONSTRUCTION UNIVERSITY

Answers to Questions by Readers on the Building of Radio and Allied Devices. Readers Should Address Questions to Radio Construction University, Radio World, 145 West 45th Street, New York, N. Y.

Coupling Metal Tubes

WHICH method of coupling the 6L7 and the 6C5 gives most sensitivity? Should a series padding condenser be between stator and coil or between coil and ground?—A. L.

The method illustrated is the less sensitive. It consists of direct coupling of 6C5 grid to Grid No. 3 of the 6L7. Hence separate 50,000 ohm leaks for these grids, with G3 to minus 10 volts or so, .00025 mfd. between grids, is a bit more sensitive. The padding condenser Cp is shown in series with coil and condenser and is all right if Cp is equal to or greater than the tuning condenser. The oscillation is less by the depicted method, but this is sometimes desirable, especially in the interest of stability. If oscillation fails, use Cp in series with the tuning condenser, i.e., between stator and grid terminal of coil.

* * *

Stopping I.F. Oscillation

IN a commercial midget universal receiver I have (a good super) there is i.f. oscillation. How can I stop it? There isn't much, but enough to be troublesome.—H. L. V.

Put a 1 mfd. paper condenser from the set side of B plus to B minus. That is, B plus after the filter choke, to B minus.

* * *

Band Pass Tuner

IS it all right to use a band pass tuner so I can have a three gang condenser on a super with no r.f. tube?—C. L.

Yes. The extra tube, however, will give better results.

* * *

Direction of Current Flow

DOES electricity flow from positive to negative or from negative to positive? There seems to be some confusion about this, does there not?—W. H.

Negative to positive, really.

* * *

What Determines Calibration

WHEN the dial of a signal generator is calibrated, does not the calibration really represent the relationship of the capacity to the inductance?—K. W. D.

Yes.

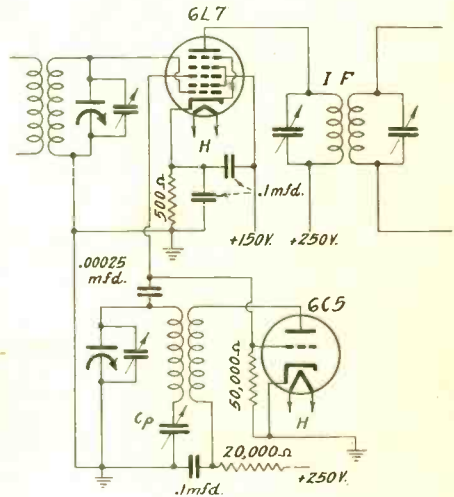

Independent negative bias for G3 of the 6L7 is avoided by the direct coupling of metal tube grids. Cp is in series with coil and tuning condenser but may be put between stator and coil.

Calibrating An Audio Oscillator

SOME time back, when you were publishing as a weekly, you gave an insight into the use of stations for audio frequency determinations, and in the monthly made some mention of it. I would like to obtain the formula, also the procedure. I desire to calibrate an audio oscillator.—I. C. F.

The method you refer to is based on the beat note produced when two unequal frequencies are mixed. Perhaps it would simplify understanding of the practice to consider the use of a broadcast band signal generator beating with broadcasting stations. Select a station and establish zero beat at or near the low frequency end of the generator dial. Suppose the frequency is 570 kc, difference frequency 0. The next generator position is marked 560 kc. Thus we may turn the generator slowly to 650 kc, receiver unmolested, and encompass an audio span of 10 kc, as much as we normally desire to calibrate in an audio oscillator. If we could graduate the small dial difference much more closely we

(Continued on next page)

RADIO UNIVERSITY

(Continued from preceding page)

would not need further assistance, and could do that with a special generator covering, say, 550 to 570 kc over its entire span. Then 20,000 cycles would be covered by the entire dial displacement, affording real possibilities. Lacking the special equipment, we may establish accurate audio frequencies by using harmonics of low frequencies of the generator. Much depends on the number and frequencies of the station the set can bring in. The station and generator frequencies must be known. The unknown audio frequency may be derived from the formula $F_x = nF_g - F_s$, where n is the harmonic order of the generator frequency F_g , and F_s is the station frequency. Transpose F_s if it is higher than nF_g . Suppose the generator is set at 142 kc and zero beat of a harmonic is established with 710 kc. Then n is equal to $710/142$, or 5. If another station, at 570 kc this time, is tuned in on the receiver, generator not molested, instead of zero beat there will be a finite beat. What is the frequency? The harmonic order is of course lower now, since the frequency of the station with which it is beating is lower. We find 4×142 equals 568 kc, the station frequency is 570 kc, and the audio frequency is the difference, or 2 kc, or 2,000 cycles. If we now slightly retune the generator to zero beat with 570 kc we have established 142.5 kc fundamental of generator, the fourth harmonic of which is used ($4 \times 142.5 = 570$). Now if we turn the receiver to pick up 710 kc, generator undisturbed, the audio tone is equal to $(5 \times 142.5) - 710$, or $712.5 - 710$, or 2,500 cycles. We now have two audio frequencies, derived from the same two stations. The 10,000 cycle terminal frequency for the audio oscillator is easily obtained, also values down to several hundred cycles, but lower values are not practically obtainable, and the line frequency may be used for 60, 120, 180, 240, 300, 360, 420 and 480 cycles. Any operations like those discussed are best performed when the two frequencies, audio beat from station and generator, and audio tone from unknown a. f. oscillator, are fed into a single tube, acting as detector, and a plate needle watched. The ear is not to be relied on, except when using harmonics of the line, a happy circumstance, since the needle for the third and higher harmonics would change little. The problem of eliminating the program that interferes with the close identity of the note is solved by reducing the antenna coupling after the station has been verified as to identity and frequency. Make up a list of all the broadcast stations you can receive well, divide their frequencies by 2, 4, etc., to 20, and tabulate the results, so that nearly equal fundamentals or subharmonics may be seen at a glance, for from these the tests will be made.

* * *

Coupling for Five Meters

WILL you please let me know what is a good way to couple the antenna to my five meter receiver? There is a coupling coil suggested in some literature I read about a similar

The ONLY TWO Companion Devices
for Reducing Noise on ALL Waves

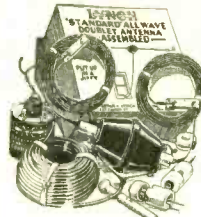

LYNCH HI-FI Assembled Antenna

All ready to hang. Saves 90% of installation time. Any novice can install it—quickly, easily, correctly. Makes every set perform better. Results are amazing.

LYNCH HI-FI ASSEMBLED ANTENNA **\$6.75** list

NOISE REDUCING TWINS

LYNCH FILTERADIO

Cuts out objectionable noise from the light line. Makes interference from circuit breakers, motor generators, etc., practically negligible. Easy to install; simple to adjust. One type serves all purposes. **\$5.00** list

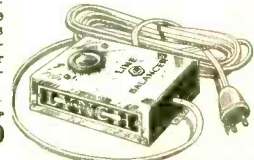

Be sure and see these NOISE-REDUCING TWINS at your jobber's or dealer's. If they cannot supply you, order direct. Write for folder.

ARTHUR H. LYNCH, Inc., 227 Fulton St., New York
Pioneer of Noise-Reducing Aerials

device, but when I tried this I found the coupling too weak. The standard method seems to be to use a series condenser and connect direct to grid, but this has not worked out so well for me.—K. M.

You can take a couple of feet of the antenna leadin wire, at the set end, and wind it up tightly, so that it forms a solenoid, say, on pencil diameter. This coil-condenser, for the capacity coupling is prodigious, may then be removed from the pencil, and slid in the core of the two-coil system used in the receiver. By altering the amount of insertion just the desired coupling may be obtained. This is in effect the series capacity coupling method, with inductive assistance.

* * *

Bias Method and Output

WILL the output from a push pull power stage be greater or less with fixed bias, compared to self bias, other factors equal?—W. D.

Fixed bias will yield the greater output. For example, with 2A3 tubes in push pull, 10 watts for self bias, 15 watts for fixed bias. The ohms load differs for fixed and self bias, so be careful to get the right matching transformer. Tube manuals give the full information on ohms load.

* * *

Why Performance Falls Down

IN a battery operated oscillator that I built, following the diagram in the December issue, page 28, I find that there is oscillation over the

low frequency coil entirely, but weak at the lowest frequencies, whereas on the intermediate coil there is no oscillation over half of the dial, on the broadcast band about the same condition, and none on the short waves, what remedy can you suggest?—Y. R.

The condition you describe is due to a faulty tube in the radio frequency oscillator socket. Since there is the same type of a tube (30) in the audio frequency oscillator socket, we suggest you transpose the tubes. The tube that did not oscillate at all dial positions on all bands at radio frequencies may be good enough for audio frequencies, where the efficiency is far higher, so much so that a good tube will serve as modulator with as little as 1.5 volts on the plate. It is of course preferable to have two excellent tubes in the generator, but in a pinch the transposition will likely enable continued service.

* * *

Power Factor Explained

FREQUENTLY I read about the power factor of a condenser, and I would appreciate an explanation of what that means. Also, the statement is made that a condenser has resistance, and the condenser is sometimes treated as if it were a resistance. Is not a condenser a capacity and is not a resistance something different from a capacity?—I. L. C.

The power factor may be considered as an expression of the losses taking place in a condenser. Thus, the greater the losses the greater the power factor. In radio frequency practice the power factor of the condenser should not be more than .007, otherwise considerable dielectric losses are indicated. So power factor applies to radio frequency values as well as to condensers used at commercial frequencies. In the filter section of a B supply the power factor of the filter condenser is of little or no consequence. Naturally, the power factor is best stated in mathematical terms, the simplest expression being that the power factor of a condenser is equal to the a.c. resistance divided by the reactance. Since the power factor is never zero, every condenser must have resistance. In power circuits power factors of .7 to .95 are encountered. The condensers are naturally being used on alternating current, as they are substantially open circuits, practically enormous resistance, to direct currents. The a.c. resistance of the condenser represents a value equal to that of a series added pure resistance that reduces the current one half. The a.c. resistance will change somewhat with frequency. However, the great change of current flow that takes place with frequency change is due to the reactance. The reactance of the condenser is determined by measuring the condenser's capacity, measuring the frequency of the voltage applied, and, multiplying the frequency in cycles, the capacity is farads and 6.28, and dividing the product thus obtained into 1. The voltage is immaterial. The mathematical form for capacity reactance X_c is

$$\frac{1}{2\pi fC}$$

We now divide the resistance by the

QUICK-ACTION CLASSIFIED ADVERTISEMENTS

7 cents a word. \$1.00 minimum.

BUILD YOUR PROSPERITY WITH SELF HELP. Opportunities on smallest capital, no experience. Write A. ROMATKA, 25 West 3rd St., New York.

200 NEW AND SUCCESSFUL MONEY-MAKING IDEAS. Only 35c postpaid. Enterprize Bureau. Syracuse, N. Y.

ZANZIBAR, also Sudan, Somaliland, Tigerstamps, Togoland, Caribbean, Archer, Algerian, Central Americans, British Colonials. This Magnificarocious Collection free for 5c Postage. Gray Stamp Co., Dept. R.W., Toronto, Canada.

PRINTING—100 each bond letterheads and envelopes, \$1.00 cash, delivered; 1,000 3 x 6 circulars, 125 words, \$1.25. **TODD PRINTERS, 325 East Fourth Street, Cincinnati, Ohio.**

REFERENCES, BIBLIOGRAPHY, furnished on Radio and Scientific Subjects. 24 hour service. Single subject only 5c per reference. Stamps accepted. Further details on request. **GENERAL SCIENCE INDEX SYSTEM, Box 176, Springfield, Mo.**

INFORMATION is wanted of Louis Le Grange, 44 years of age, born in New York City, of medium height, thin, has black hair and eyes, straight nose, thin lips, broadcasts over the radio, his specialty is whistling—who deserted his wife Rose and their three minor children, Vivian, Herbert and Winifred, in October, 1929, from the Bronx, N. Y. City. In 1933, after posting a bond at Court he disappeared and since that time has not supported his family at all, as a result of which they are dependent on the public charities. Kindly communicate with the National Desertion Bureau, 67 West 47th Street, N. Y. City.

COILS and other radio parts for all circuits designed by Jack Goldstein and J. E. Anderson. Pie wound i.f. coils, all frequencies. Matched broadcast and foreign short wave band coils for .00035 mfd. **RADIO DESIGN CO., 1353 Sterling Place, Brooklyn, N. Y.** (Note new address.)

**WHEN WRITING TO ADVERTISERS
PLEASE MENTION THAT YOU SAW THE
ADVERTISEMENT IN RADIO WORLD.**

reactance and obtain the power factor. Perhaps you are more familiar with the equivalent case with coils. The power factor for inductances is the resistance divided by the reactance. Commercial broadcast coils may have values from .01 to .0025. Large coils as used at broadcasting stations may have power factors of .003 or even less. Hence the smaller the losses the smaller the power factor. The "Q" of a coil or a circuit is the reciprocal of the power factor. The higher the "Q", or the lower the power factor, the better the tuning coil.

Standard Radio-Telegraph Signal Set

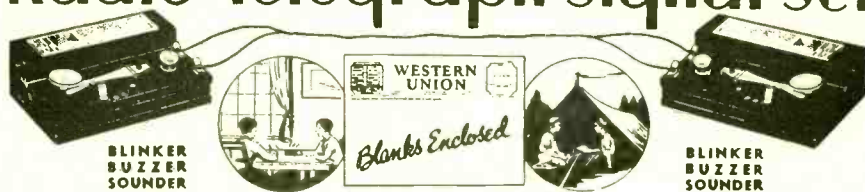

3 TYPES OF APPARATUS IN 1

IT BUZZES! *As Used in Radio*

IT FLASHES! *As Used in Night Signaling*

IT CLICKS! *As Used in Telegraphic Transmission*

The Standard Radio Electric Telegraph Set is the easiest set to connect and operate. By following the simple instructions inclosed with every set you will be able to learn how to send and receive messages in telegraph code. Thousands of professional operators on ships and railroads learned the code using sets of this type. Each set is completely wired for sending and receiving. By connecting wires between sets, messages may be sent and received from a distance.

One of the first important steps in becoming a radio amateur is to learn the code. The use of these sets makes this accomplishment quick and sure.

Single sets—without accessories	98c
Double sets— without accessories	\$1.98
Single sets, with 1¼" x 4½" double-cell battery	\$1.14
Double sets, including 50 feet insulated wire, and two double-cell batteries as described above	\$2.39
Single 1½ volt batteries, may be obtained separately at 8 cents each, and double batteries, 1¼" x 4½", 3 volt output, at 15 cents each.	

Dealers: Get in touch with your nearest jobber, or write to us direct.

LEOTONE RADIO CO.

63 DEY STREET

NEW YORK CITY

You need these 2 books MATHEMATICS of Radio Servicing

Introduces and explains the use of arithmetic and elementary algebra in connection with units, color code, meter scales, Ohm's Law, alternating currents, ohmmeter testing, wattage rating, series and parallel connections, capacity, inductance, mixed circuits, vacuum tubes. curves, the decibel, etc, etc., and has numerous examples.

Plainly written and easy to understand. Only useful data included. M. N. Beitman, author. Size, 8½ x 11 in.

PRINCIPLES of PUBLIC ADDRESS SYSTEMS

A practical handbook, full of useful information, fully illustrated, written by M. N. Beitman, an engineer and noted authority on audio amplifiers.

Considers in detail various microphones, radio and phonograph inputs, acoustic feedback, mixing and volume controls, use of vacuum tubes, interstage coupling, power amplifiers, output coupling, loud speaker placement, the decibel, P.A. measurements, power level, and other points of importance, including actual circuit diagrams of tested P.A. systems.

Price, 50c each book.

SUPREME PUBLICATIONS
3727 West 13th St. Chicago, Illinois

THOR RADIO CO.

167 GREENWICH STREET
Near Cortlandt St. New York City

The largest radio store in New York devoted exclusively to Parts and Experimenters Supplies.

Radio World Advertising Rates GENERAL ADVERTISING

	1 time	12 times
Full Page—5½x8"	\$75.00	\$60.00
½ Page—5½x4" or 2½x8"	37.50	30.00
¼ Page—2½x4"	18.75	15.00
⅛ Page	9.38	7.50
One inch, single column	5.00	4.00
Agate line38	.34
Classified—7c. per word, minimum \$1.00.		

Color Pages (2 colors):

Inside front cover	\$90.00
Inside rear cover	90.00
Back cover	90.00

When writing to advertisers, please mention
Radio World.

METAL CHASSIS

We can supply chassis for any make receiver, experimental or otherwise. Inquiries should be accompanied with sketch and complete details enabling us to give quick service as to prices and delivery.

KORROL MFG. CO., Inc. Dept. R.W.-36
322 GREENWICH ST. NEW YORK CITY

Let Me Tell You

About your business, travel, changes, matrimony, love affairs, friends, enemies, lucky days and many other interesting and important affairs of your life as indicated by astrology. Send for your special Astral Reading. All work strictly up-to-date, individual and guaranteed satisfactory. FOR MANY YEARS PRIVATE ASTROLOGICAL ADVISER TO ROYALTY and the ELITE. Write name, address and date of birth plainly. No money required, but if you like send 15 cents (stamps; No Coins) to help defray costs. Address: PUNDIT TABORE, (Dept. 517-A), Upper Forjett Street, BOMBAY VII, BRITISH INDIA. Postage to India is 5c.



MAILING LISTS



GET OUR FREE
REFERENCE
BOOK and
MAILING
LIST CATALOG

FREE

Gives counts and prices on accurate guaranteed mailing lists of all classes of business enterprises in the U. S. Wholesalers—Retailers—Manufacturers by classification and state. Also hundreds of selections of individuals such as professional men, auto owners, income lists, etc.

Write today for your copy

R. L. POLK & CO.

Polk Bldg.—Detroit, Mich.
Branches in Principal Cities

World's Largest City Directory Publishers
Mailing List Compilers. Business Statistics. Producers of Direct Mail Advertising.

NEW! H. G. CISIN'S Metal Tube ALL ELECTRIC AIR SCOUT

Only Set of its Kind in the World

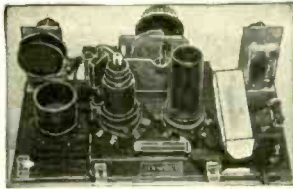

Rear view showing New Metal Tubes

Pat. Pending U. S. Serial No. 592,586. Operates on A.C. or D.C. Self-Contained Power Supply.

POWERFUL—Many Air Scout owners report reception from England, Germany, Spain, Rome and other foreign stations. W. C. Angell, Jr., of Providence, R. I., logged 12 foreign stations the first week. Wonderful short wave reception. Broadcast reception on indoor aerial. Police calls, code, aeroplane and Trans-Atlantic phone conversations. **NEW METAL TUBES—GREATER SENSITIVITY.** Four plug-in coils cover 10 to 200 meters. Extra coils for Broadcast Reception, also Special long wave unit. Operates several headsets simultaneous. Speaker on strong stations.

Complete, Assembled Kit, with and picture diagram, and all four short wave coils, ready to wire.... **\$3.95**

Set of Matched Metal Tubes.....\$2.50

Special Long Wave Unit w. Coil. 550 to 1500 meters95

Broadcast Coils (Two) 1.45

Earphone (single)50
Total\$9.35

SPECIAL COMBINATION OFFER—
Assembled Kit, metal tubes, 7 coils including Long Wave Unit, earphone **\$8.40**

Above: Custom-Built, wired and laboratory tested, ready to use, \$1.00 extra.

10c to cover printing, etc., brings copy of new booklet, "SHORT WAVE TRAVEL TIPS," including valuable world short wave log and all-wave data! Order at Once!

H. G. CISIN

Chief Engineer
Allied Engineering Institute

98 PARK PLACE

Dept. 2C.

NEW YORK, N. Y.

MILES AHEAD OF OTHERS

Since 1923 MILES has been specializing in the manufacture of the better type **AMPLIFIERS, MICROPHONES, HORNS, GIANT UNITS** and Complete Sound Systems.

ANNOUNCING JANUARY SPECIALS:—

TYPE 12—Complete Portable Public ADDRESS SYSTEM for 110 volts AC and DC and 6 Volts. Two portable cabinets each measuring 9" x 12" x 18". One cabinet comprises the complete Amplifier, pre-amplifier, vibrator, controls, switches and Speaker for 110 Volts AC and DC, the other cabinet containing a 6-Volt built-in speaker.

Enough volume with two speakers to cover an audience of up to 2000. May be used indoors or outdoors. Additional speakers may be used. Complete (less tubes) and including a genuine MILES HAND-LAPEL MIKE and cable. Special Introductory.....NET PRICE, \$79.50

MILES SOCKET MIKE (Pat. Pend.), operates in conjunction with your "MIKE" and or PHONO throughout an entire building without INTERCONNECTING wires. **NO WIRING . . . NO INSTALLATION . . . NO LOST TIME . . . NO ERRORS . . . TALK or PLAY** from one department or floor to another **INSTANTANEOUSLY!**

TYPE KZ—In kit form including Diagram and instructions. Spec. Net, \$16.75

TYPE MZ—Completely wired (less tubes).....Spec. Net, \$21.75

WE RECONDITION YOUR OLD CARBON MICROPHONE FOR ONLY \$4.50

300 Other Public Address Components and Most Complete Line of Miles Transformers. Bulletins Upon Request.

MILES REPRODUCER CO., Inc.,
114 West 14th Street

Dept. RW 22
NEW YORK

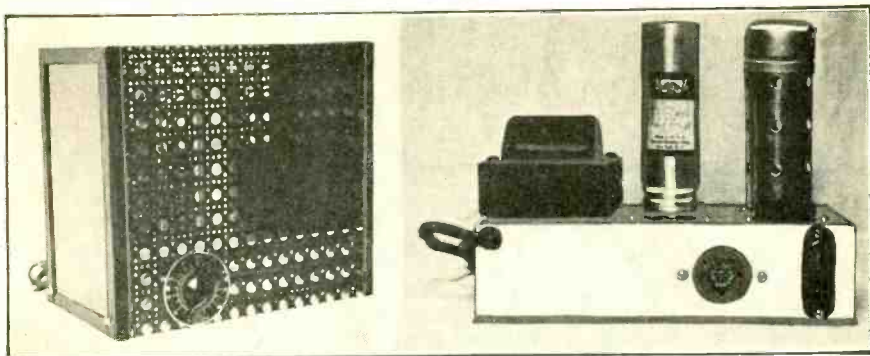

THE NEW RSL-5 AMPLIFIER

A MODERN UNIT TO MEET MODERN NEEDS

An ideal unit for lodge halls, class rooms, restaurants, taverns and many other places where an inexpensive powerful amplifier is needed. A radio tuner or phonograph pickup can be used for entertainment purposes

The RSL-5 uses, 1-57, 1-2B6, 1-83 in a circuit designed to give high gain and true reproduction. Output 5 watts. The unit is enclosed in a strong black crackle finished case and cover which have been designed to provide proper ventilation and easy access to all controls and jacks.

COMPLETE KIT OF PARTS—LESS TUBES AND SPEAKER.....\$7.95
 8½" DYNAMIC SPEAKER (not illustrated).....\$2.79

SEND 3c STAMP FOR FREE CIRCUIT DIAGRAM

RADIO SCIENCE LABORATORIES

126 LIBERTY STREET
 NEW YORK, N. Y.

STUYVESANT ELECTRIC CO., INC.

140 Washington St., N. Y. C.

Phone: COrt. 7-4411

WHOLESALE DISTRIBUTORS

FOR

- | | |
|--|---|
| Eveready Batteries
C. R. L. Volume Controls
Thordarson Transformers
Sprague Condensers
Jensen Speakers
Packard Record Changers
General Industries Motors
Webster Pickups
Ohmite Resistors
Triplett Meters
Speer Resistors
Eby Products
Rola Speakers
Universal MicroPhones
Signal Keys
Federal Condensers
Weston Meters
Hickok Meters | Astatic Crystal Pickups
United Sound Amplifiers
Carron Cones
Pioneer Genemotors
H & H Switches
General Transformers
Radiart Vibrators
Readrite Meters
Wright de Coster Speakers
Snapit Products
Utah Chargers
Baldwin Phones
Metal Etching Products
Carter Controls
Crowe Dials
Upo Pickups
Clough-Brengle Meters
Hytron Tubes |
|--|---|

WE SELL WHOLESALE EXCLUSIVELY

*Dealers who are interested write, call,
 or phone for salesman to call on them*

WHEN WRITING TO ADVERTISERS
 PLEASE MENTION THAT YOU SAW THE
 ADVERTISEMENT IN RADIO WORLD.

Want a Steady Job?

\$1260 to \$3400 a year

Work for "Uncle S" Paid Vacation

Men - Boys 18 to 50

Common Education unusually sufficient, Valuable Coupo

Mail It Today SURE

FRANKLIN INSTITUTE, Dept. E-205 Rochester, N. Y.
 Rush to me FREE OF CHARGE list of U. S. Govern-
 ment jobs now obtainable. Send FREE 32 page book
 telling salaries, duties, hours, etc. Tell me how I can
 get a position.
 Name _____
 Address _____

NEW "RACO" DIRECT READING SIGNAL OUTSTANDING — ALL WAVE — GENERATORS

MODEL 339 A. C. and D. C. OPERATED

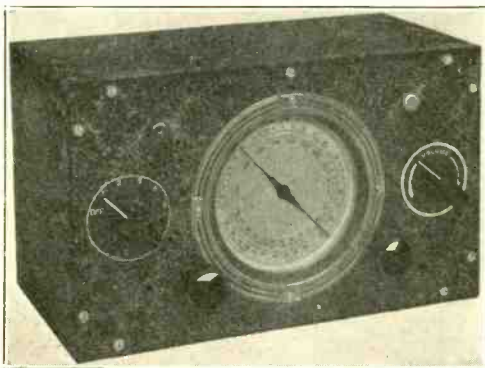

MODEL 339. A 5-band Signal Generator, 54 to 17,000 kc. all on fundamentals, switch operated, direct reading in frequency and wavelength; universal operation. Modulation on-off switch and attenuation. Electron coupled. Wired, tested, calibrated, with three tubes (6D6, 37 and neon). Shipping weight, 8 lbs. **\$16.00**

measurements of frequencies up to 100 mc (down to 3 meters) simplified harmonic system to the 5,400 to 17,000 kc fundamental. The 339 has a 6D6 r.f. oscillator, a 37 rectifier tube, so that d.c. is used on the plate, while modulation is provided by a neon tube relaxation oscillator at a frequency of about 1,000 cycles. Model 339, wired, calibrated, adjusted, complete with three tubes, ready to operate; instructions (shipping weight, 8 lbs.). **\$16.00**

Model 339K, complete kit, instructions, less only tubes. \$12.50

MODEL 339B BATTERY OPERATED

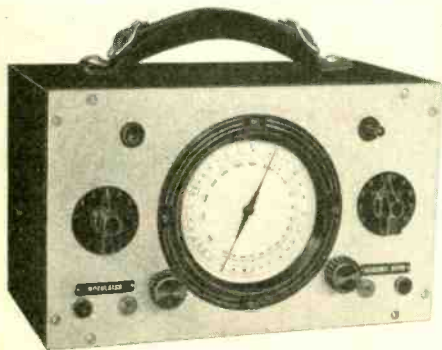

The Model 339-B Portable Signal Generator in a handle-equipped black wrinkle finish shield cabinet, the front panel finished in "Raco Wrinkle Illuminite," wired, complete with A and B batteries, two 30 tubes, r.f. attenuator, variable audio frequency control, selector switch, r.f. and a.f. output jacks, and "Frequency Meter" and "Modulator" nameplates. (Shipping weight, 11 lbs.)... **\$15.10**
NET

**Model 339 B Kit, less tubes
and batteries \$11.50**

THE highest requirements of precision and convenience for all-around work are met in the Model 339 Signal Generator that works on a.c. or d.c. of 90-125 volts, to measure frequencies from 54 to 17,000 kc and line up channels. It also serves for determining the frequency of a station that is being received. Model 339 is outstanding because though all-wave, switch type, with airplane dial, attenuator and removable modulation, it is priced at only \$16.00 net.

The frequencies are in five bands, all on fundamentals:
(1)—5,400 to 17,000 kc. (2)—1,700 to 5,400 kc.
(3)—540 to 1,700 kc. (4)—170 to 540 kc.
(5)—54 to 170 kc.

It can be seen from the above that the calibration is decimal repeating, by noting left-hand column alone, then right-hand column alone. Thus two calibrations afford maximum spreadout, each at outside of dial scale. The two inside scales are for reading wavelengths, 18 to 5,500 meters.

Coincidence of generated frequency and scale reading is 1 per cent. This high order of accuracy obtains in no other instrument selling at less than twice the cost of the 339.

Many, no doubt, have been somewhat confused by the numerous types of signal generators, but will note that the best of them cover wide ranges on fundamentals, have an attenuator, and permit of presence or absence of modulation. Also they have a vernier dial and are direct reading in frequencies, accurate to at least 3 per cent. The 339 has all these advantages, besides affording wavelength determinations as well, and operation on 90-125 volts a.c. (any commercial frequency) or d.c. And the accuracy is three times as great. Moreover, the 339 is well built, for lifetime use, and covers all waves fundamentally, besides permitting by resort to a slight calculation method, applying a band.

OUTSTANDING FEATURES

(1)—Frequencies are direct reading to an accuracy of 1 per cent., using Raco's own calibrated dial and precision inductances, and a precision variable condenser (54 kc to 17,000 kc).

(2)—Radio frequency output has an attenuator that does not molest the frequency generated, no matter where the attenuator is set.

(3)—A tone is impressed on the radio frequency generated, or not, as you prefer, to allow for both methods of alignment. A throw of a switch introduces or removes the tone.

(4)—The audio frequency generated may be varied by adjustment of a control marked in arbitrary graduations, 1 to 10. This enables measurement through interference.

(5)—Besides the radio frequency output jacks, there are separate jacks for the audio frequency output, and since this audio frequency may be adjusted, tests may be made of response characteristics of audio amplifiers.

(6)—Stabilization of the radio frequency oscillator.

(7)—Stabilization of the audio frequency, and independence of the audio frequency from any setting of the radio frequency tuning condenser.

(8)—Modulation is about 50 per cent., when introduced in the r.f. oscillator, double peaks are thus completely avoided.

RADIO CONSTRUCTORS LABORATORIES

136 LIBERTY STREET
Dept. W-211, N. Y. City

RADIO Made EASY

(1)—Write for FREE NEW CATALOG of Condensers, Transformers, Chokes, Sockets, Coils and technical data on receiving and transmitting equipment.
 (2)—Attach 10c for New 32-page Manual of most popular Short-Wave Receivers, with illustrations, diagrams and parts lists.

Address Dept. RW-136
 HAMMARLUND MANUFACTURING CO.
 424-438 W. 33rd St., New York



A HIT AS A MONTHLY SPECIAL 2-FOR-1 OFFER RADIO WORLD

The How-To-Make-It Magazine.

In Its New Monthly Form.

Radio World is \$2.50 a year (12 issues), 25c per copy. Canada and foreign, \$3.00 yearly. Offers of Radio World and other worthwhile publications for one full year on each, (NET):

- RADIO WORLD and SHORT-WAVE CRAFT, \$3.50.
- RADIO WORLD and POPULAR SCIENCE MONTHLY, \$3.50.
- RADIO WORLD and RADIO-CRAFT (12 issues) \$3.50.
- RADIO WORLD and RADIO INDEX (monthly, 10 issues) stations, programs, etc., \$3.50.
- RADIO WORLD and SERVICE (monthly) \$3.50.
- RADIO WORLD and EVERYDAY SCIENCE AND MECHANICS (monthly) \$3.50.
- RADIO WORLD and BOYS' LIFE (monthly, 12 issues) \$3.50.
- RADIO WORLD and MOTION PICTURE MAGAZINE (monthly) \$3.50.
- RADIO WORLD and MOVIE CLASSIC (monthly) \$3.50.
- RADIO WORLD and PICTORIAL REVIEW (monthly) \$3.00.
- RADIO WORLD and SCREENLAND (monthly) \$3.50.
- RADIO WORLD and TRUE STORY (monthly) \$3.00.
- RADIO WORLD and LIBERTY (weekly) \$3.00 U. S. only.

Select any one of these magazines and get for an entire year by sending in a year's subscription for RADIO WORLD at the regular price, \$2.50, plus a small additional amount, per quotations above. (Add \$1.50 for extra foreign or Canadian postage for both publications.)

Name

Address

City and State

- If renewing an existing or expiring subscription for RADIO WORLD, put cross in square.
- If renewing an existing or expiring subscription for other magazines, put cross in square.

Special Trial Offer for Radio World only: \$1.00 for 5 months, postpaid. Mail order with remittance to Radio World Office. NET.

RADIO WORLD, 145 W. 45th St., New York

Build Better

ESICO ELECTRIC SOLDERING IRONS

With Esico Soldering Irons

The Esico electric soldering iron demanded by the leading plant superintendents in the country, because of their efficiency—is just the iron you need to complete your home kit of quality tools.

HOT—QUICK SOLDERING—INEXPENSIVE

See your local Esico distributor on a complete line of Esico soldering irons.

ELECTRIC SOLDERING IRON CO., INC.
 342 West 14th Street New York, N. Y.



RACO Transceiver With Battery Compartment

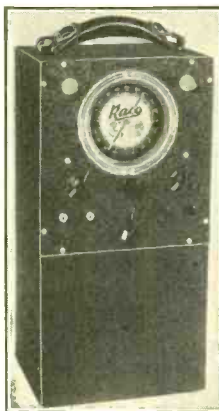

OUR Unity Coupled 5 Meter Transceiver, using two 19 tubes and one 30, five tube performance, has just been redesigned for complete portability. Room has been provided for two No. 6 dry cells and three 45 volt B batteries. Range up to 100 miles, depending on conditions. The airplane dial is a new feature, exclusive with us in transceiver construction.

Complete kit... \$10.95
 Assembled, wired 3.00
 Cabinet 1.50
 Matched tubes... 1.65

Four-Inch airplane dial marks new RACO Transceiver Wiring diagram with each kit.

We have literature also on 5 and 10 meter receiver, 2-tube a.c. transceiver, universal 15-550 meter switch-type receiver, 1-tube transceiver and all wave switch super.

SEND FOR CIRCULARS

RADIO CONSTRUCTORS LABORATORIES
 136 Liberty St., Dept. R.W., N. Y. City

TRY THIS TESTER AT YOUR JOBBERS



MODEL 710-A

**CHECKS
ALL PARTS
OF RADIO
CIRCUITS
USING
GLASS OR
METAL TUBES**

DEALERS NET PRICE Only \$16.50

This popular three meter set tester checks all parts of radio tube circuits by plugging directly into the receiving set sockets.

- D.C. Voltmeter Scale 20-60-300-600
- D.C. Milliammeter Scale 15-150
- A.C. Voltmeter Scale 10-140-700

Model 710-A, in Black Leatherette Case, complete with all necessary connections. Dealer Net Price..... **\$16.50**

Model 712-A, Same as 710-A but having Triplet moving coil, Model 223, 2" D.C. Voltmeter. (1,000 ohms per volt). Dealer Net Price **\$22.50**

OTHER READRITE PRODUCTS

Readrite also manufactures all types of testers used for servicing radio sets, including: Set Testers, Tube Testers, Oscillators, Resistance, Continuity and Capacity Testers, Point-to-Point Testers and inexpensive Indicating Meters.

MAIL THIS COUPON

READRITE METER WORKS
227 College St., Bluffton, Ohio

Please send me more information on

.....Model 710-AModel 712-A

.....New Catalogue

Name

Address

City..... State.....

TESTERS AND METERS